

www.atten.com

ATTEN

Product Catalog

2022



ABOUT US

- ✧ One of the largest and most powerful electronic instrument and electronic tool manufacturers in China, located in Guangming District, Shenzhen City since it was founded in 1996.
- ✧ The member of China Soldering Station Industry Standard Committee and National Standardization Technical Committee of Home Appliances.
- ✧ Transferred successfully from an OEM factory into a widely accepted brand enterprise and was titled many times as the “National New High-tech Enterprise” through continuously brought in professional work staff and international management principles.
- ✧ A system work solution provider experienced in developing, manufacturing, sales and after-sales services, and focused in the following two industrial categories:
 1. Advanced soldering and desoldering tools including lead-free soldering station, hot air station, rework system, BGA rework station.
 2. Linear DC power supply, switching power supply and programmable power supply.
- ✧ Enterprise obtained ISO9001:2015 quality control system. Products approved by CE, RoHS 2.0, UKCA, KC, SAA and CCC.
- ✧ Establishing worldwide distribution network and local cooperation partnership.



CONTENT

Multifunctional Maintenance System

GT-6150	02
GT-6200	02
GT-5150	03
GT-8102	03
GT-8100	05
MS-900	07
GT Series Accessories	09
MS-300	13
MS-500	15

Soldering / Desoldering Station

ST-1509	17
ST-1503, ST-1503D	18
ST-80, ST-909, ST-100	20
T990/T500 soldering tips	21
T800 soldering tips	22
ST-2090D	23
AT-937, AT-989, AT-989D	24
ST-8800D	25
ST-8802	26
AT-852D, AT-850D	27
AT8502D	28
T900 soldering tips	29
Nozzles	30
Handle	32
GT-2010+	33
ST Series Soldering Iron	34

Tool Accessories

Solder Stand	35
Temperature tester ST-1090	36
Magnifying Frame & Solder Smoke Absorber	37
Hot Melting Glue Gun, Tweezers	38
Soldering tip cleaner, Tin Slag Box & Rosin Flux	39
Soldering Wire	40
Soldering Wire Stand & Solder Pot	41
Soldering Wick	42
Desoldering tool & Vacuum pick-up tool	43
Tip Refresher & Rosin Flux flux & Solder paste flux	44
Wrist Strap & Wrist Strap On-line Monitor	45

POWER SUPPLY

APS15-3A/APS22-5A	46
TPR3003T/TPR3005T	47
TPR32-5A / TPR75-2A	48
TPR6005T/TPR6010T	49
TPR3020T/TPR3010T	50
KPS3030DA/KPS3050DA	51
TPS300P	52
CP600-30V/30A/CP900-30V/30A	53
PR35-3A-3C / PR35-5A-3C	55
PR35-3A-3CP / PR35-5A-3CP	57

GT Series soldering system



Rapid temp recovery

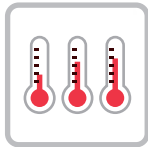

Preset temp



ESD safe



Auto sleep



Password function



Auto standby



°C/°F available



Fault display



Automatic identification



Software Control

Computer control

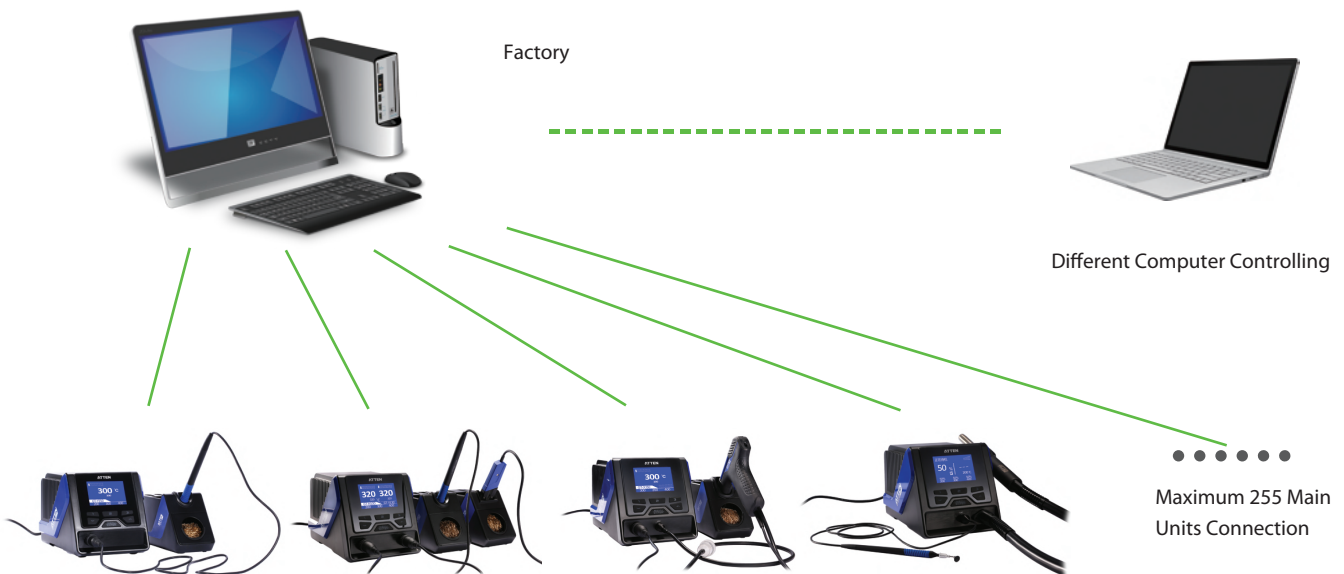

GT-6150

Single channel high- end Intelligent unleaded soldering station



Features:

- Compatible with various type of soldering tools, utility model with multiple functions.
- Max Power is 150W.
- Big silicone buttons operate comfortable and reliable.
- All kinds of parameter data and information in the form of graphics display.
- Can automatically recognize the soldering tools and upload the corresponding parameters.
- Provide 3 groups shortcut temperature to simplify operations.

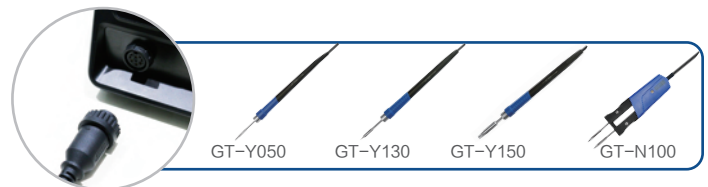

Automatic identification

GT-6200

Dual channel high- end Intelligent unleaded soldering station



Features:

- Compatible with various type of soldering tools, a machine serves several purposes.
- Whole machine max power is 200W.
- Two output channels can work at the same time.
- Big silicone buttons operate comfortable and reliable.
- All kinds of parameter data and information in the form of graphics display with its large LCD screen.
- Can automatically recognize the soldering tools and upload the corresponding parameters.
- Provide 3 sets shortcut temperature to simplify operations.

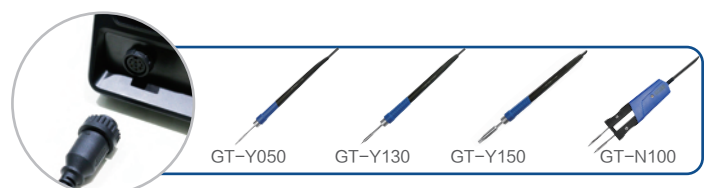

Automatic identification

GT-5150

Single channel high- end Intelligent unleaded suction soldering station



Desoldering Nozzles

Features:

- Compatible with various type of soldering tools, one machine serves several purposes.
- Built- in vacuum suction pump.
- Max power is 150W.
- Big silicone buttons operate comfortable and reliable.
- All kinds of parameter data and information in the form of graphics display with its large LCD screen.
- Can automatically recognize the soldering tools and upload the corresponding parameters.
- Provide 3 sets shortcut temperature to simplify operations.

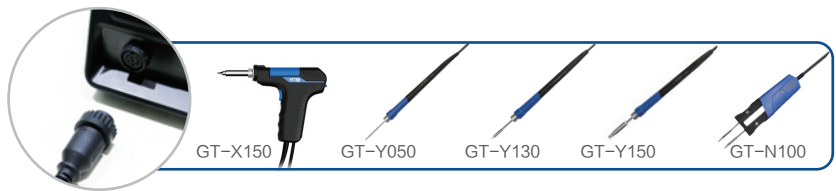

Automatic identification

GT-8102

Intelligent high power hot air rework station



A1604
Φ4mm



A1606
Φ6.5mm



A1609
Φ9.5mm

Features:

- LCD display making parameters monitorable and system setting easier.
- Equip with vacuum suction pen, components can be extracted after desoldering.
- Installed brushless fan, air volume can reach 120 L/min.
- 1000W high power heating core, heating up fast.
- Support timing work & password function.
- 3 sets shortcut air volume/temperature are available.
- Temperature compensation, fixed temperature, upper & lower temperature limits making temperature's management easier.
- Automatic standby/air delay after power-off function makes work safer.

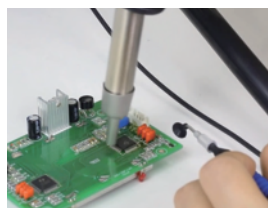

Specification:

Pictures				
Model	GT-6150	GT-6200	GT-5150	GT-8102
Voltage	AC(100V/110V/120V 220V/230V/240V) 50/60Hz (Optional)			
Power	150W	200W	150W	1000W
Temperature range	150°C~480°C	150°C~480°C	300°C~480°C	100°C~480°C
Temperature stability	±2°C (in still air, no load)	±2°C (in still air, no load)	±2°C (in still air, no load)	±5°C (in still air, no load)
Handle	GT-Y130	GT-Y130, GT-N100	GT-X150	GT-R102
Soldering tip	T130-1.0I	T130-1.0I, T100-0.5I	Desoldering Nozzles: 3 PCS	Nozzles:(φ4mm、φ6.5mm、φ9.5mm)
Soldering tip/heater	Integrated	Integrated	Integrated HS-5150	Integrated HR-2102
Soldering stand	S-01	S-01, S-02	S-03	Air gun holder
Inner box	37.5x34.5x22.5(cm)	45.8x37x22.5(cm)	63.5x32x24(cm)	43x32.5x24(cm)
N.W.	4.11KG	4.97KG	5.05KG	5.08KG
G.W.	6.33KG	7.61KG	7.32KG	6.81KG
Package list	GT-6150 host: 1 Set Operation manual: 1 Set Power cord : 1 Pcs Certificate of qualification : 1 Pcs 3.5mm grounding receptacle : 1 Pcs GT-Y130 handle set : 1 Pcs S-01 Iron stand : 1 Pcs	GT-6200 host: 1 Set Operation manual: 1 Set Power cord : 1 Pcs Certificate of qualification : 1 Pcs 3.5mm grounding receptacle : 1 Pcs GT-Y130 handle set : 1 Pcs S-01 Iron stand : 1 Pcs GT-N100 tweezers handle : 1 Pcs S-02 Iron stand : 1 Pcs	GT-5150 host: 1 Set Operation manual: 1 Set Power cord : 1 Pcs Certificate of qualification : 1 Pcs 3.5mm grounding receptacle : 1 Pcs GT-X150 desoldering gun : 1 Pcs S-03 Iron stand : 1 Pcs	GT-8102 host: 1 Set Operation manual: 1 Set Power cord : 1 Pcs Handle holder : 1 Pcs Spray nozzle : 3 Set Vacuum pen : 1 Set Hot air gun handle: 1 Pcs Conformity certificate: 1 Set Tool box : 1 Set Suction disc: 4x3 Pcs
Applicable	<ul style="list-style-type: none"> ● Institutes/Enterprises ● Education and practice ● Maintenance ● Hobby 			



Note: GT series optional handles details in page 7.



Note: Integrated heater details in page 8-9.(T50/T100/T130/T150)



GT-8100



Intelligent Industrial IOT Hot Air Station



Features:

- LCD display making parameters monitorable and system setting easier.
- Equip with vacuum suction pen, components can be extracted after desoldering.
- Installed brushless fan, air volume can reach 120 l/min.
- 1300W high power heating core, heating up fast.
- Support timing work & password function.
- 3 sets shortcut air volume/temperature are available.
- Temperature compensation, fixed temperature, upper & lower temperature limits making temperature's management easier.
- Automatic standby/air delay after power-off function makes work safer.
- With RS485 communication interface.

Model	GT-8100
Voltage	AC(100V/110V/120V 220V/230V/240V) 50/60Hz (Optional)
Power	1300W
Temperature range	100°C~500°C
Air flow	120L/min(Max)
Timing range	10-900S
Heater	Pluggable HR-2102B
Computer control	Yes
Inner box	374x273x190mm
N.W.	3.54kg
G.W.	4kg
Package list	GT-8100 host: 1 Set Operation manual: 1 Set Power cord : 1 Pcs Certificate of qualification : 1 Pcs Handle : 1 Pcs Spray nozzle : 2 Pcs
Applicable	<ul style="list-style-type: none"> ● Institutes/Enterprises ● Education and practice ● Maintenance ● Hobby

Nozzles details in page 31.

IOT Function

GT-8100

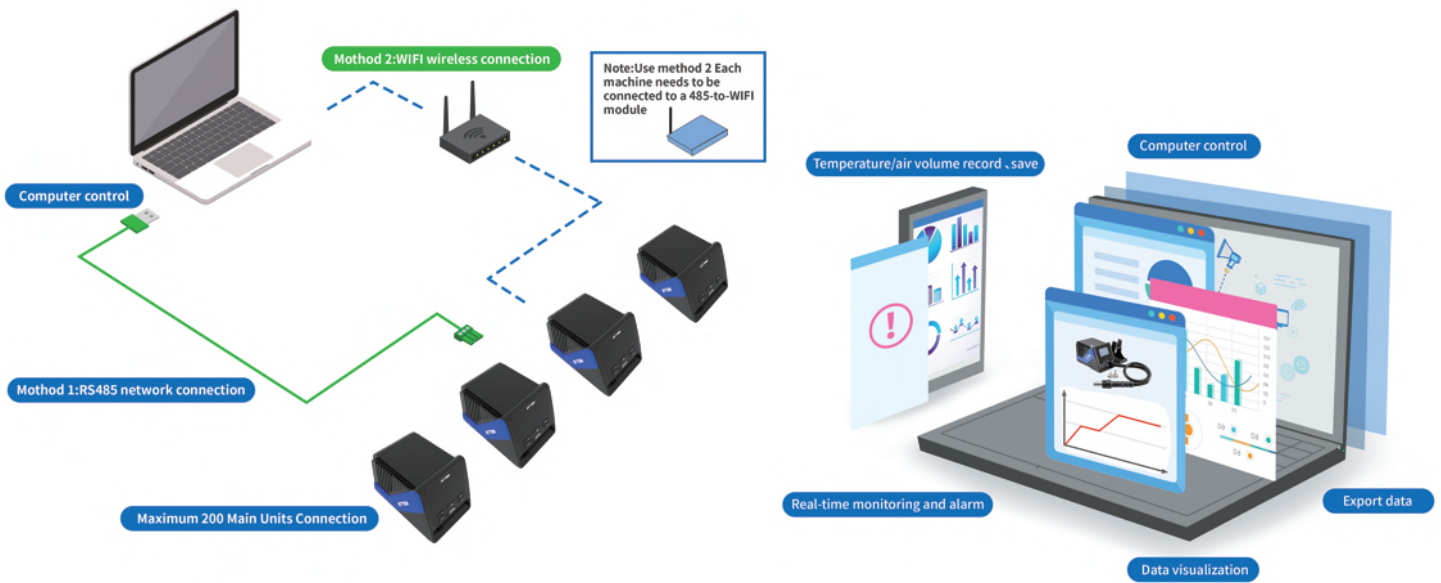

Intelligent management platform

Soldering station built-in 485 communication module(Wireless communication module can also be installed),can be docked with intelligent management platform software system,Realization: interconnected real-time monitoring, process preservation and copying, data storage and traceability, statistical analysis and management, monitoring and alarm prompts, remote control.

MS-900 **ESD SAFE**

4 In 1 Intelligent Rework Station



Applicable:

- High accuracy MCU control is employed to synchronously detect whether the 3 tool channels can be used independently and synchronously without mutual interference.
- Built-in vacuum generator
- Super power. The whole machine can provide a maximum of 900W power output.
- Stand-alone machine can carry out multiple desoldering tasks simultaneously.
- Large screen graphics display screen which can display all kinds of parameter data and messages graphically.
- The contents can be presented abundantly and intuitively.
- Automatically identify all kinds of welding tools and load corresponding parameters.
- The software can adjust the temperature automatically which is more accurate and convenient.
- Fault display and alarm functions available
- Functions such as standby, buzzer ringing, temperature lock and factory data reset available
- Support communication interface. It can access to a computer, and complete various settings following the specified program.
- Vacuum desoldering pen is added to facilitate dismantle the desoldering components.

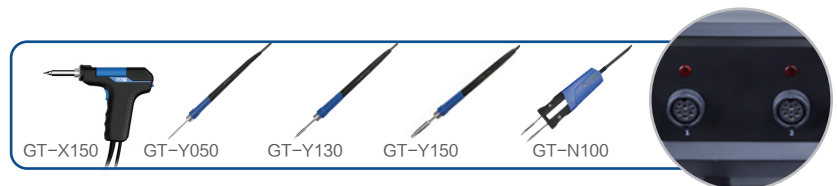
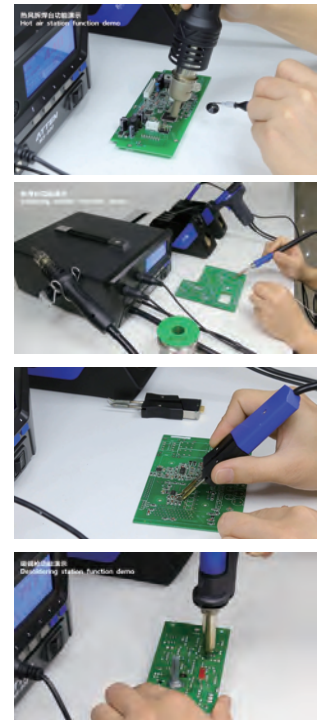

Automatic identification

Specification:

Model		MS-900		
Voltage	AC(100V/110V/120V 220V/230V/240V) 50/60Hz (Optional)			
Total Power	900W			
Main unit	Hot Air Station	Soldering Station	Desoldering Station	Electronic Tweezers
Power	Heater 550W Air pump 25W	130W	Heater 150W, Vacuum pump 15W	100W
Handle	AP-552B	GT-Y130	GT-X150、GT-B001	GT-N100
Temperature range	150°C~500°C	150°C~500°C	300°C~500°C	150°C~500°C
Standby	No Standby	200°C	300°C	200°C
Standby time	No function	1~120 minutes (0 i.e. standby deactivated)	1~120 minutes (0 i.e. standby deactivated)	1~120 minutes (0 i.e. standby deactivated)
Air flow grades	23L/Min			
Noise	<52dB(A)			
Temperature stability	±5°C	±2°C	±2°C	±2°C
Temperature compensation	- 50~+50°C			
Lock setting	Available			
Tip to ground impedance	<2Ω			
Tip to ground voltage	<2mV			
Overall dimension	310(L)x251(W)x119(H)			
Weight	N.W.: 14KG		G.W.: 16KG	
Package:	Main unit: 1 set Air gun of soldering station: 1 pc Soldering iron stand: 1 pcs Desoldering station handle: 1 pc Electric tweezer handle: 1 pc Desoldering gun handle: 1pc Desoldering pen handle: 1pc Power cord: 1 pc	Blow-dryer bracket: 1 pc Screw: 2 pcs Suction disk: 11 pcs Spring: 3 pcs Suction nozzle: 3 pcs Rubber washer: 2 pcs Desoldering nozzle: 3 pcs Nozzle: 4 pcs	Desoldering gun front plug: 2 pcs Desoldering gun O-ring 6x1.5: 2 pcs Desoldering gun O-ring: 2 pcs Desoldering tube liner: 1 pc Filter cotton: 10 pcs Dust-absorbing sponge: 10 pcs Spring pin(cleaning pin): 1 pc Anti-ironing mat: 1 pc	User Manual: 1
Applicable	<ul style="list-style-type: none"> ● Institutes/Enterprises ● Education and practice ● Maintenance ● Hobby 			

GT Series

Accessories

GT-Y050

50W Mini Soldering iron

50W mini soldering iron, suitable for small welding components

GT-Y130

130W Soldering iron

130W middle size soldering iron, suitable for most welding components

GT-Y150

150W High- power Soldering iron

150W high- power soldering iron with sufficient heat energy, suitable for welding large bonding pad and weldments

GT-N100

100W Tweezers handle

With soldering and desoldering function, suitable for soldering and desoldering various SMD devices

GT-X150

150W Desoldering gun

High power, heating up quickly, minimize damage to PCB boards. New design with replaceable nozzle, heat conducting quickly, high efficiency and low cost



Integrated heater (50W)

<p>T50-0.1IS T950-0.1IS</p>	<p>T50-0.3IS T950-0.3IS</p>	<p>T50-0.1SI T950-0.1SI</p>	<p>T50-0.3SI T950-0.3SI</p>
<p>T50-0.5I T950-0.5I</p>	<p>T50-1.2C T950-1.2C</p>	<p>T50-K T950-K</p>	<p>T50-2.0SK T950-2.0SK</p>
<p>T50-1.3D T950-1.3D</p>	<p>T50-2.2D T950-2.2D</p>	<p>T50-3.0D T950-3.0D</p>	<p>T50-3.5SK T950-3.5SK</p>

Integrated heater (100W)



<p>T100-0.5I T9100-0.5I</p>	<p>T100-1.3D T9100-1.3D</p>
<p>T100-2.2D T9100-2.2D</p>	<p>T100-1.0I T9100-1.0I</p>

Desoldering Nozzles (T151)

<p>T151-0.8 ACF029749</p>	<p>T151-1.0 ACF029633</p>	<p>T151-1.3 ACF029634</p>	<p>T151-1.6 ACF029635</p>
-------------------------------	-------------------------------	-------------------------------	-------------------------------

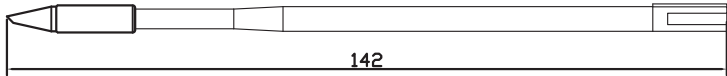

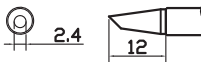
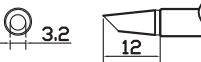
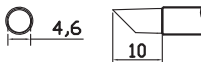
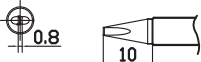
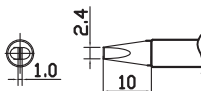
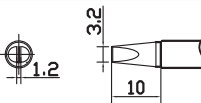
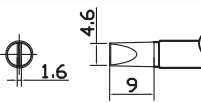
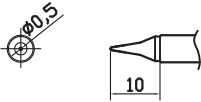
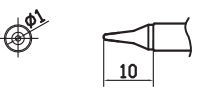
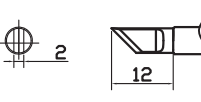
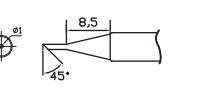
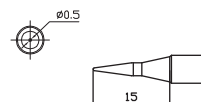
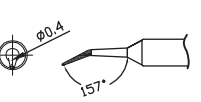
Integrated heater (130W)

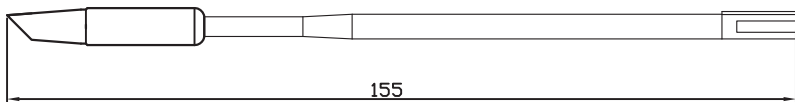

 <p>T130-1.2C T9130-1.2C</p>	 <p>T130-2.4C T9130-2.4C</p>	 <p>T130-3.2C T9130-3.2C</p>	 <p>T130-4.6C T9130-4.6C</p>
 <p>T130-1.6D T9130-1.6D</p>	 <p>T130-2.4D T9130-2.4D</p>	 <p>T130-3.2D T9130-3.2D</p>	 <p>T130-4.6D T9130-4.6D</p>
 <p>T130-0.5I T9130-0.5I</p>	 <p>T130-1.0I T9130-1.0I</p>	 <p>T130-K T9130-K</p>	 <p>T130-C T9130-C</p>
 <p>T130-SI T9130-SI</p>	 <p>T130-0.5IS T9130-0.5IS</p>	 <p>T130-SK T9130-SK</p>	

Integrated heater (150W)

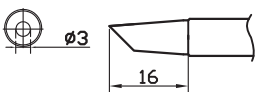

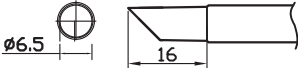
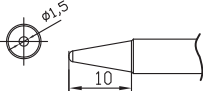
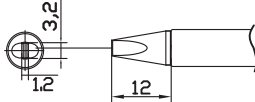
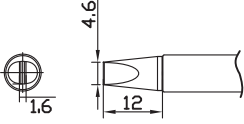
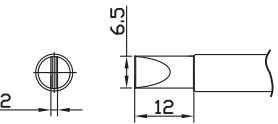
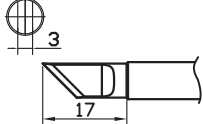
 <p>T150-3C T9150-3C</p>	 <p>T150-5C T9150-5C</p>	 <p>T150-6.5C T9150-6.5C</p>	 <p>T150-B T9150-B</p>
 <p>T150-3.2D T9150-3.2D</p>	 <p>T150-4.6D T9150-4.6D</p>	 <p>T150-6.5D T9150-6.5D</p>	 <p>T150-K T9150-K</p>

GT Series Soldering handles Performance Test



HEATING UP TIME TEST

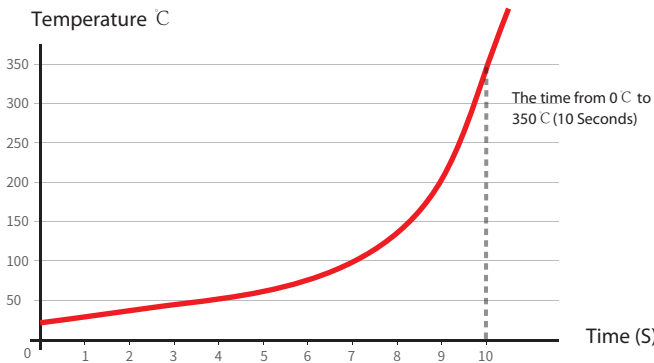

Fast heating up to set temperature, speed up working efficiency.

DROP TEMPERATURE RECOVER TIME CONTROL CURVE

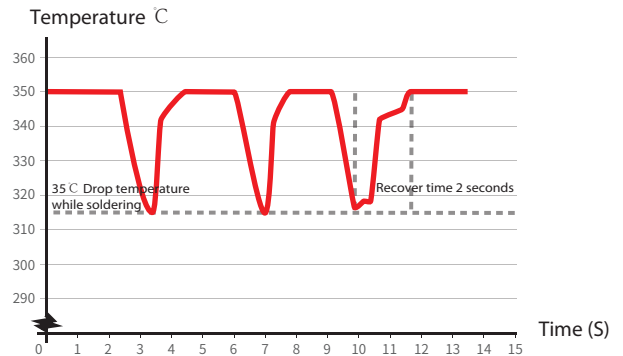

AUTO STANDBY & AUTO SLEEP ILLUSTRATION

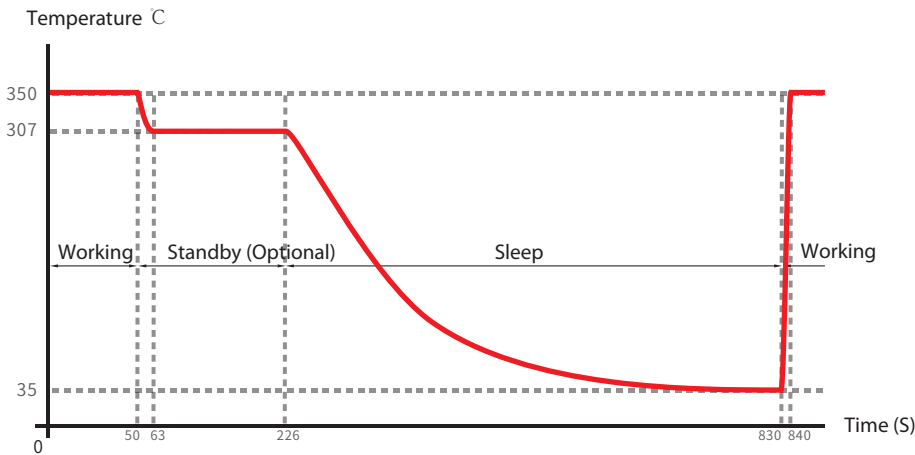

- After put handle on holder, standby function can automatically reduce the temperature of nozzle.
- Once reached standby time, the machine will enter auto sleep mode.
- Once power off, the temperature of nozzle will reduce to room temp.
- After power on, the temperature of nozzle quickly heating up to set temperature.

THE SERVICE LIFE OF NOZZLE CAN BE EXTENDED 5 TIMES AT MOST

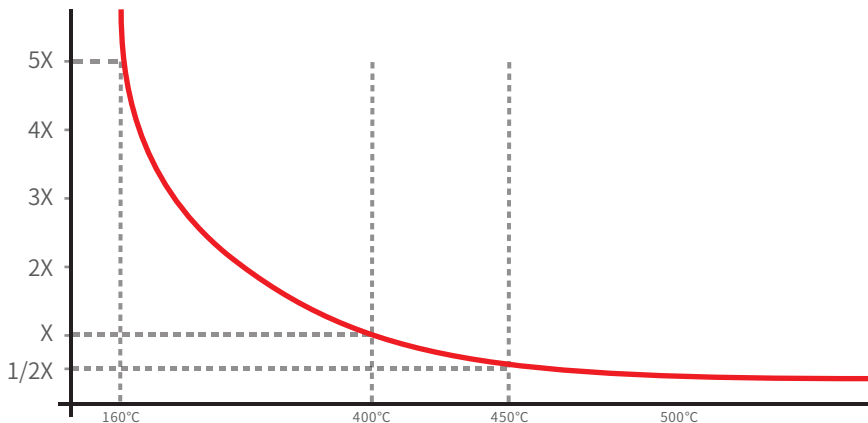

Using the nozzle base on the temperature illustration, the service life of nozzle can be double extended.

The function of auto sleep, could protect nozzle to extend 5 times of service life.

MS-300 **ESD SAFE**

3 In 1 rework station



Specification:

Product pictures				
Item No	ST-862D	ST-965	APS15-3A	
Power	1000W	65W	56W	
Temperature range	100°C~480°C	80°C~450°C	Ripple and noise	CV≅0.5mVrms
Air flow	130L/min(Max),20L/min(Min)		Protection function	OCP(support automatically recovery)/OHP
Heater	Pluggable HR-2102A	Pluggable HS-3065A	USB interface	Fixed 5V output(±5%), maximum 2.1A output(overcurrent protection, stop outputting)
Soldering tip type	Nozzles:4 PCS	T900-0.2IS	Heat-dissipating method	Smart fan control
Working condition	Temp:0°C~40°C Humidity: <80%	Temp:0°C~40°C Humidity: <80%	Working condition	Temp:0~40°C Humidity: <80%
Storage condition	Temp:-20°C~80°C Humidity: <80%	Temp:-20°C~80°C Humidity: <80%	Storage condition	Temp:-20~70°C Humidity: <80%
Dimensions	210x174x150(mm)	210x88x150(mm)	Size	210x80x150(mm)
N.W.	3.34kg	1.97kg	N.W.	2.4kg
Applicable	<ul style="list-style-type: none"> ● Institutes ● Enterprises ● Education and practice ● Maintenance ● Hobby 			

Note: T900 series soldering tip details in page 30.

Hot Air Station ST-862D



Features:

- LCD display screen making control visualization.
- Temperature unit switching function.
- Temperature locking ,timed work function.
- MCU controlled temperature calibration,compensation for constant working .
- Strong air volume with brushless fan.
- Easy to replace with pluggable heater.
- Convertible with straight air and spiral air.
- Auto-sleep function.

The standard nozzles : A-2605 A-2664 B-2608 B-2610
A-2600 nozzle converter

Note: ST-862D nozzles details in page 28.

Soldering Station ST-965



Features:

- Automatic standby, shutdown with smart time setting.
- Beep alarm function available.
- Temperature locking, temperature calibration and temperature alarming function.
- Password protecting function and temperature unite switching function
- MCU controlled temperature calibration.
- New design with LCD display screen making control visualization.
- Buttons(1,2,3) for pre-setting or switching frequentlyused temperature.

Power Supply APS15-3A



Features:

- Controlled by MCU digital and series adjustment, low ripple, low noise and high stability.
- Designed with double types of tables, more suitable for telecommunication devices.
- Fast dynamic load response speed, optimized proceed for communication equipments.
- Support automatically recovered overcurrent protection(OCP) and overheating function(OHP).
- Independent USB interface, which can provide current 2.1A output, support overcurrent and short circuit protection.

MS-500 **ESD SAFE**

3 In 1 rework station



Specification:

Product pictures				
Item No	ST-862D	ST-1509	APS22-5A	
Power	1000W	150W	125W	
Temperature range	100°C~480°C	80°C~480°C	Ripple and noise	CV ≤ 0.5mVrms
Air flow	130L/min(Max), 20L/min(Min)		Protection function	OCP(support automatically recovery)/OHP
Heater	Pluggable HR-2102A	Integrated	USB interface	Fixed 5V output(± 5%), maximum 2.1A output(overcurrent protection, stop outputting)
Soldering tip type	Nozzles:4 PCS	T950-0.1IS	Heat-dissipating method	Smart fan control
Working condition	Temp:0°C~40°C Humidity: <80%	Temp:0°C~40°C Humidity: <80%	Working condition	Temp:0~40°C Humidity: <80%
Storage condition	Temp:-20°C~80°C Humidity: <80%	Temp:-20°C~80°C Humidity: <80%	Storage condition	Temp:-20~70°C Humidity: <80%
Dimensions	210x174x150(mm)	210x88x150(mm)	Size	210x80x150(mm)
N.W.	3.34kg	3kg	N.W.	2.4kg
Applicable	<ul style="list-style-type: none"> ● Institutes ● Enterprises ● Education and practice ● Maintenance ● Hobby 			

Note: T900 series soldering tip details in page 30.

Hot Air Station ST-862D



Features:

- LCD display screen making control visualization.
- Temperature unit switching function.
- Temperature locking ,timed work function.
- MCU controlled temperature calibration,compensation for constant working .
- Strong air volume with brushless fan.
- Easy to replace with pluggable heater.
- Convertible with straight air and spiral air.
- Auto-sleep function.

The standard nozzles : A-2605 A-2664 B-2608 B-2610
A-2600 nozzle converter

Note: ST-862D nozzles details in page 28.

Soldering Station ST-1509



Features:

- Design with LCD display screen making control visualization.
- Buttons(1,2,3) for pre-setting or switching frequently used temperature.
- Auto sleep ,auto standby ,auto shutdown function to keep soldering work safer and extend machine lifespan .
- Has temperature locking, temperature calibration ,temperature alarming ,auto shutdown heating , password protecting function .
- Temperature read out in $^{\circ}\text{C}$ and $^{\circ}\text{F}$.
- Compatible with various type of soldering tools .
- Heating-up very fast with replaceable integrated heater.

Note: Integrated heater details in page 8-9.(T950/T9100/T9130/T9150)

Power Supply APS22-5A



Features:

- Controlled by MCU digital and series adjustment, low ripple, low noise and high stability.
- Designed with double types of tables, more suitable for telecommunication devices.
- Fast dynamic load response speed, optimized proceed for communication equipments.
- Support automatically recovered overcurrent protection(OCP) and overheating function(OHP).
- Independent USB interface, which can provide current 3A output, support overcurrent and short circuit protection.

ST-1509

Intelligent Soldering Station



heater

Features:

- Design with LCD display screen making control visualization.
- Buttons(1,2,3) for pre-setting or switching frequently used temperature.
- Auto sleep ,auto standby ,auto shutdown function to keep soldering work safer and extend machine lifespan .
- Has temperature locking, temperature calibration ,temperature alarming ,auto shutdown heating , password protecting function .
- Temperature read out in $^{\circ}\text{C}$ and $^{\circ}\text{F}$.
- Compatible with various type of soldering tools .
- Heating-up very fast with replaceable integrated heater.

Specification:

Item No	ST-1509			
Voltage	AC(100V/110V/120V 220V/230V/240) 50/60Hz			
Power	150W			
Temperature range	80 $^{\circ}\text{C}$ ~480 $^{\circ}\text{C}$			
Temperature accuracy	$\pm 10^{\circ}\text{C}$			
The handle type	Y950 /Y9130 /Y9150 /N9100 optional			
Soldering tip/Heater	T950-0.1IS T950-2.0SK / T9130-1.0I T9130-K / T9150-K T9150-B / T9100-0.5I optional			
Soldering stand	S-13			
Package list	Main unit: 1unit AC cord: 1 PCS	Iron Stand: 1PCS integrated heater with tip: 2 PCS	Manual: 1 PCS	Iron Handle Set: 1PCS
Standard Packing	Inner box: 28.2x21x18.7(cm) N.W.: 3kg G.W.: 3.3kg Carton: 6PCS/Carton Size: 43.5x30x58(cm) N.W.: 19.8kg G.W.: 20.8kg			
Applicable	<ul style="list-style-type: none"> ● Production line ● Education and practice 	<ul style="list-style-type: none"> ● Institutes ● Maintenance 	<ul style="list-style-type: none"> ● Enterprises ● Hobby 	

Note: Integrated heater details in page 10–11.(T950/T9100/T9130/T9150)

ST-1503/ST-1503D

**ESD
SAFE**

High frequency soldering station



Features:

- All kinds of parameter data and information in the form of graphics display.
- MCU controlled temperature calibration, compensation for constant working .
- High power and Great thermal recovery.
- Provide 3 groups shortcut temperature to simplify operations.
- Temperature read out in °C and °F.
- Intelligent temperature calibration function.
- Intelligent temperature control fan, suitable for high-intensity work
- ST-1503D With RS485 communication interface

Specification:

Heater HS-3150H

Item No	ST-1503	ST-1503D
Voltage	AC(100V/110V/120V 220V/230V/240) 50/60Hz	
Power	150W	
Temperature range	80°C~600°C	
Soldering tip	T500-4C	
The handle type	SP-H150	
Heater	HS-3150H	
ITO Function	No	Yes
Tip-to-ground impedance:	<2Ω	
Tip-to-ground voltage:	<2mV	
Standard Packing	Inner box: 29x26x18.5(cm) N.W.: 5kg G.W.: 5.5kg Carton:4PCS/Carton Size: 30.5x53.5x39.5(cm) N.W.: 22kg G.W.: 23kg	
Applicable	<ul style="list-style-type: none"> ● High frequency and high power, fast temperature recovery, suitable for soldering big solder joints ● Suitable for soldering and desoldering the big solder joints in industrial products ● Widely used in the production line of all the kinds of enterprises 	

Note: T500 series soldering tip details in page 21.

IOT Function

ST-1503D

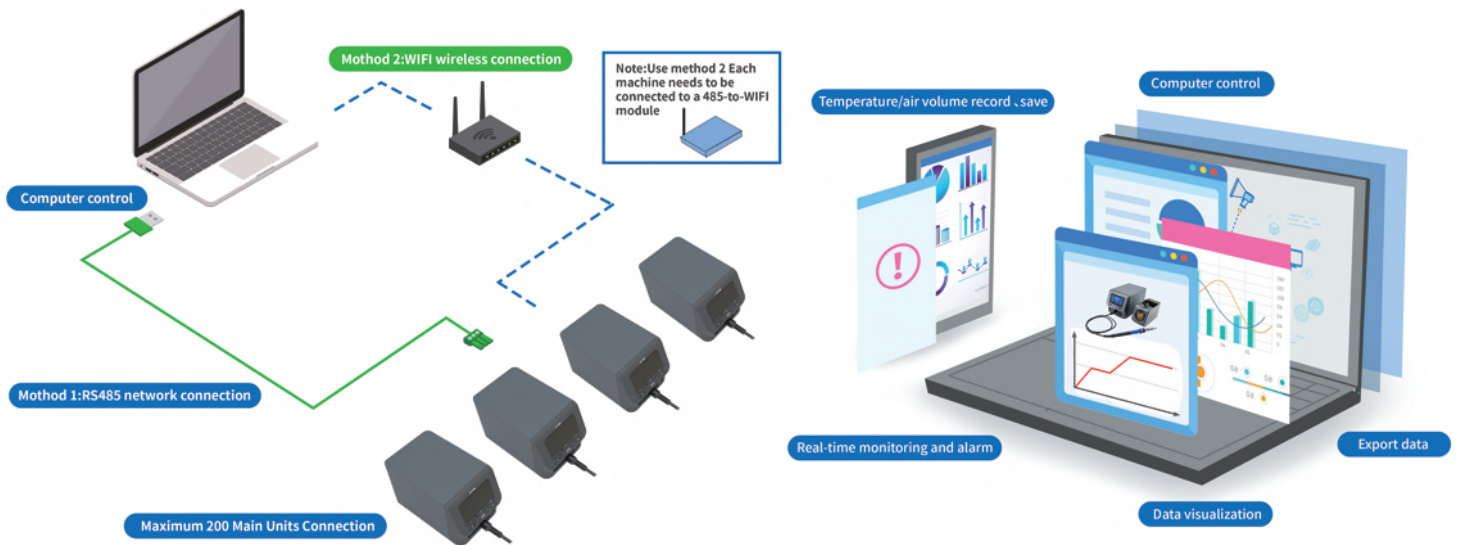

Intelligent management platform

Soldering station built-in 485 communication module(Wireless communication module can also be installed),can be docked with intelligent management platform software system,Realization: interconnected real-time monitoring, process preservation and copying, data storage and traceability, statistical analysis and management, monitoring and alarm prompts, remote control.

ST Series Soldering Station



Features:

- Temperature locking.
- Beep alarm function available.
- MCU controlled temperature calibration.
- User-friendly menu enables system setting easier.
- Separate iron stand to save room and to make easier deposit.
- Buttons(1,2,3) for pre-setting or switching frequently used temperature.
- Low-voltage heater separated from power supply to keep soldering work safer.

Specification:

Product pictures			
Item No	ST-80	ST-909	ST-100
Voltage	AC(100V/110V/120V 220V/230V/240) 50/60Hz		
Power	80W	90W	100W
Temperature range	150°C~480°C	200°C~500°C	150°C~480°C
Temperature Stability	±2°C(in still air,no load)	±2°C(in still air,no load)	±2°C(in still air,no load)
The handle type	SP-80	SP-990	SP-100
Soldering tip type	T900-B	T990-K	T800-0.25I
Heater	High performance four-core ceramic heater HS-3080	Integrated heater	Sliver alloy heater HS-3100
Package list	Main unit: 1unit Handle set : 1 PCS	Iron stand: 1 PCS AC cord: 1 PCS	Manual: 1 PCS Cleaning sponge: 1 PCS
Standard Packing	Inner box: 31.5x27x15.2(cm) N.W.: 2.09kg G.W.: 2.32kg Carton: 6PCS/Carton Size: 55.5x33x48(cm) N.W.: 14.4kg G.W.: 15.4kg	Inner box: 24.6x22.4x14.2(cm) N.W.: 2.2kg G.W.: 2.4kg Carton: 8PCS/Carton Size: 50.7x46.3x30.9(cm) N.W.: 19.2kg G.W.: 20.0kg	Inner box:31.5x27x15.2(cm) N.W.: 2.68kg G.W.: 2.95kg Carton: 6PCS/Carton Size: 55.5x33x48(cm) N.W.: 17.9kg G.W.: 19.0kg
Applicable	<ul style="list-style-type: none"> ● Institutes ● Enterprises ● Education and practice ● Maintenance ● Hobby 		

Note: T800 series soldering tip details in page 22. T990 series soldering tip details in page 21.
T900 series soldering tip details in page 29.

Soldering tips (T990)

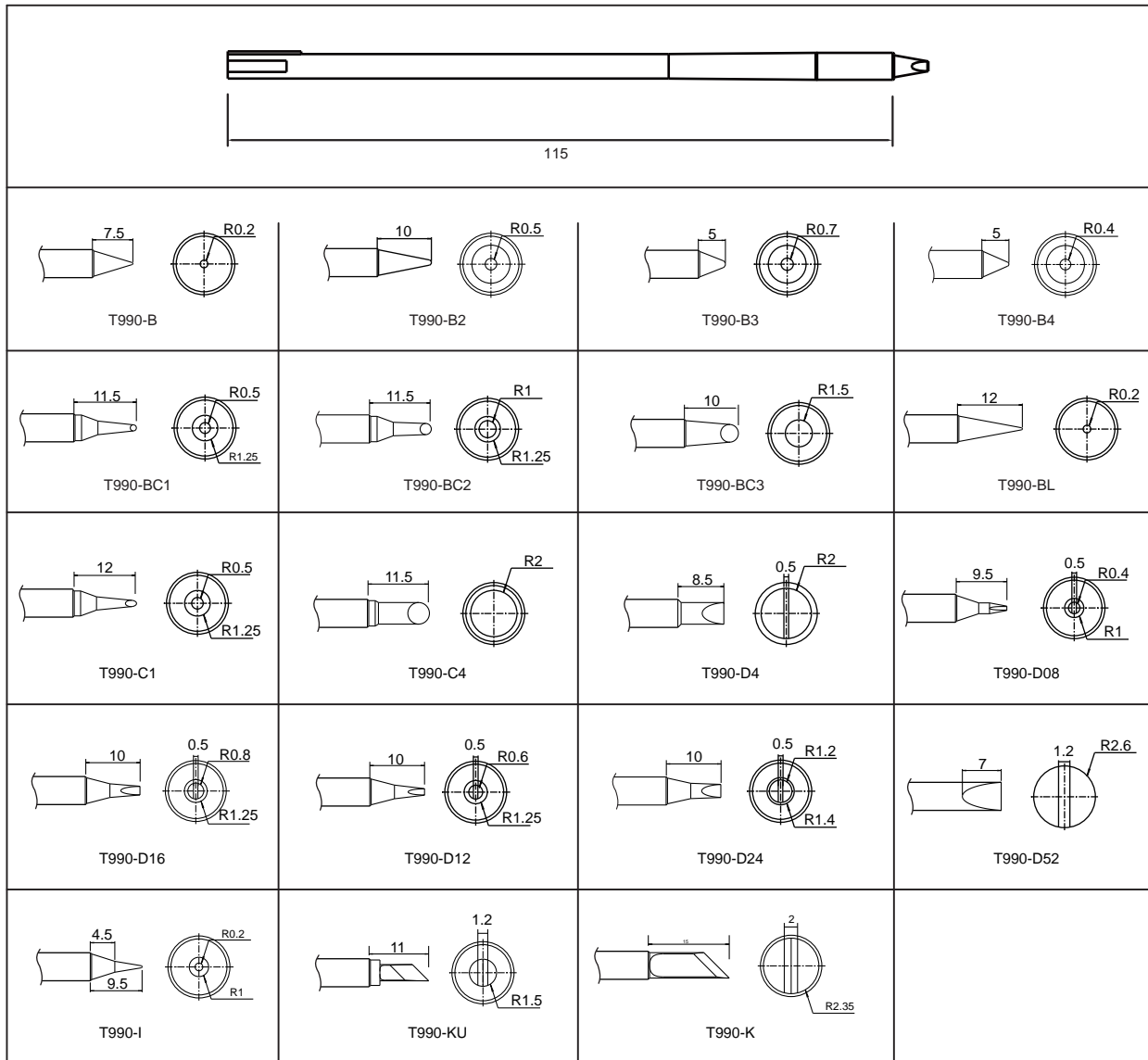

Soldering tips(T500)

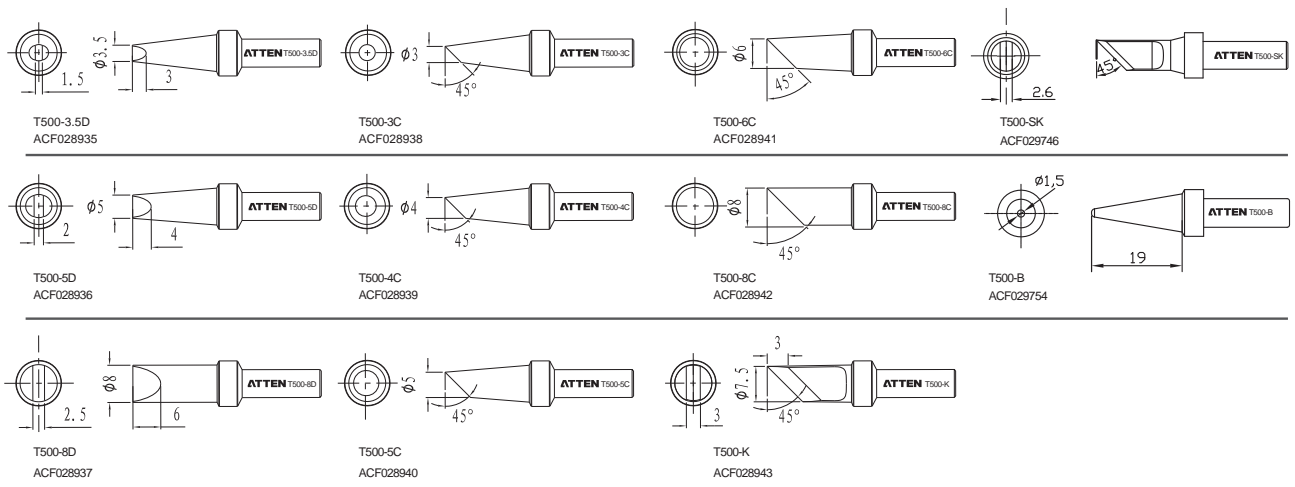

Soldering tips (T800)



T800-0.25I
ACF028944

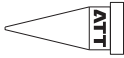

T800-1.2C
ACF028948

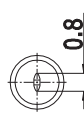
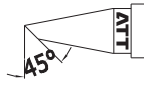

T800-0.8D
ACF028952

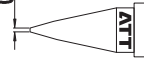

T800-4.6D
ACF028955

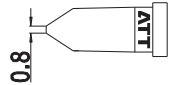

T800-0.5I
ACF028945

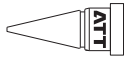

T800-2.4C
ACF028949

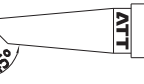

T800-1.6D
ACF028953



T800-K
ACF028956

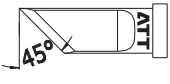

T800-1.0I
ACF028946



T800-3.2C
ACF028950

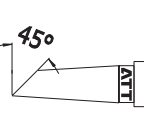

T800-3.2D
ACF028954

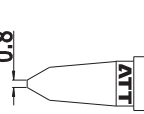

T800-4.6C
ACF028951

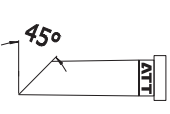

T800-1.4I
ACF028947

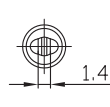

T800-2.4D
ACF029745

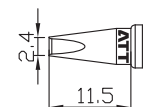

T800-SK
ACF029744

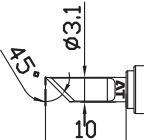

T800-0.25ILF
ACF028957



T800-2.4CLF
ACF028960

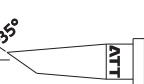

T800-1.2CLF
ACF028958

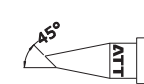

T800-2.4DLF
ACF028959

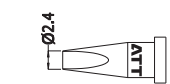

T800-2.0KLF
ACF028963

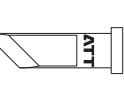

T800-1.6DLF
ACF028961

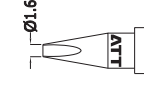

T800-3.2DLF
ACF028962

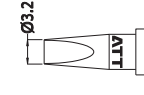

ST-2090D

Multifunctional Soldering Station



Features:

- This product designed with digital led segmented display
- Combined soldering station with soldering stand.
- MCU controlled temperature calibration with PID system equipped, adjust temperature by knob button, easy to operate.
- The handle structure is ergonomically designed for comfortable grip.
- The heating wire and sensor are made of PTC material, which is quick in temperature rise and precise in temperature control.
- Auto-standby, auto-shut down is available.
- Using 3 cored power cable.

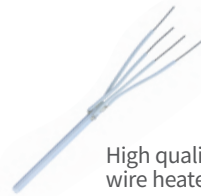

High quality four-core wire heater HS-2065A

Specification:

Item No	ST-2090D	
Voltage	110/240V AC	
Power	80W	
Temperature range	80°C~480°C	
Temperature accuracy	±15°C	
Temperature Stability	±2°C(in still air,no load)	
Temperature unit	°C/°F	
Soldering tip type	T900-B	
Package list	Main unit (including machine, power cable and handle)x1pc Soldering wire holder x 1pc User manual x 1pc	
Standard Packing	Inner box: 20x18x12.5(cm) N.W.: 0.7kg G.W.: 0.91kg Carton: 12PCS/Carton Size: 41.5x37.5x39(cm) N.W.: 11kg G.W.: 11.8kg	
Applicable	<ul style="list-style-type: none"> ● Production line ● Education and practice 	<ul style="list-style-type: none"> ● Institutes ● Maintenance ● Enterprises ● Hobby

Note: T900 series soldering tip details in page 30.

AT-937 **ESD SAFE**

ESD Safe Constant Temperature Controllable Soldering Station



AT-989 **ESD SAFE**

ESD Safe Constant Temperature Controllable Soldering Station



AT989D **ESD SAFE**

ESD Safe Constant Temperature Controllable Digital Soldering Station



Features:

- MCU controlled temperature calibration with PID system equipped.
- The heater using low voltage AC source to ensure the antistatic and no leakage, no interference.
- Legerity handle suitable for long time operation.
- Unique temperature locks setting to avoid adjusting temperature.

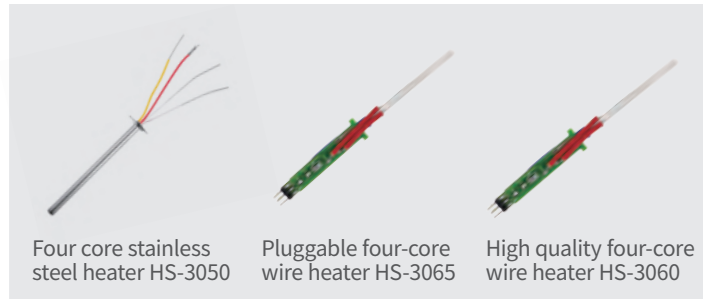

Specification:

Item No	AT-937	AT-989	AT-989D
Voltage	AC(100V/110V/120V 220V/230V/240) 50/60Hz		
Power	50W	65W	65W
Temperature range	200°C~480°C	200°C~480°C	80°C~480°C
Temperature Stability	±2°C(in still air,no load)	±2°C(in still air,no load)	±2°C(in still air,no load)
The handle type	AP-50	AP-65A	AP-60A
Soldering tip type	T900-B	T900-B	T900-B
Heater	Four core stainless steel heater	High quality four-core wire heater	High quality four-core wire heater
Package list	Main unit: 1unit Handle set : 1 PCS	Iron stand: 1 PCS AC cord: 1 PCS	Manual: 1 PCS Cleaning sponge: 1 PCS
Standard Packing	Inner box: 25x21x13.4(cm) N.W.: 1.73kg G.W.: 2.00kg Carton: 12Carton/Carton Size: 51.5x44x43(cm) N.W.: 24.0kg G.W.: 25.0kg		
Applicable	● Production line ● Education and practice	● Institutes ● Maintenance	● Enterprises ● Hobby

Note: T900 series soldering tip details in page 30.

ST-8800D ESD SAFE

Intelligent hot air station



A-2000 nozzle converter for all nozzles of AT-852D, AT-850D and AT-8502D



A-2131

A-2104

A-2102

A-2105



heater HR-2700A

Features:

- Large LCD screen; Temp/Air adjust easily.
- Touch sensor inside, auto sleep function will take effect when hot air gun placed on the stand.
- Use brushless vortex fan making cyclone air output more gentle and evenly.(Offer 4 nozzles).
- Has automatic large air volume cooling function, effectively protect the life of heating core and handle.
- Has independent cold air function, can deal with special use purpose.
- Three sets of quick temperature keys, can be set and save independently, use easily.
- Has password protection and key lock function, make control easily.
- With timing function and temperature compensation function, make use flexibly.

Specification:

Item No	ST-8800D			
Voltage	AC(100V/110V/120V 220V/230V/240) 50/60Hz			
Power	800W			
Temperature range	100°C~500°C			
Temperature accuracy	±35°C			
Air flow	30-120L/Min			
Standby heater cooling function	Support			
Beep alarm function	Available			
Package list	Main unit: 1unit Gun Holder : 1 PCS	Hot air gun: 1 PCS AC cord: 1 PCS	Manual: 1 PCS Nozzles: 4 PCS	Nozzle converter
Standard Packing	Inner box: 35.2x23x20(cm) N.W.: 1.56kg G.W.: 1.75kg Carton: 4PCS/Carton Size: 48x37x42(cm) N.W.: 7kg G.W.: 7.8kg			
Applicable	<ul style="list-style-type: none"> ● Production line ● Education and practice 	<ul style="list-style-type: none"> ● Institutes ● Maintenance 	<ul style="list-style-type: none"> ● Enterprises ● Hobby 	

Nozzles details in page 30.

ST-8802

Double Channels rework system



High quality four-core wire heater HS-3060

heater HR-2700A

A-2131 A-2104
A-2102 A-2105

Features:

- Large LCD screen; Temp/Air adjust easily.
- Touch sensor inside, auto sleep function will take effect when hot air gun placed on the stand.
- Use brushless vortex fan making cyclone air output more gentle and evenly.(Offer 4 nozzles).
- Has automatic large air volume cooling function, effectively protect the life of heating core and handle.
- Has independent cold air function, can deal with special use purpose.
- Three sets of quick temperature keys, can be set and save independently, use easily.
- Has password protection and key lock function, make control easily.
- With timing function and temperature compensation function, make use flexibly.

Specification:

Item No	ST-8802			
Voltage	AC(100V/110V/120V 220V/230V/240) 50/60Hz			
Name	Hot air station		Soldering station	
Total Power	800W		65W	
Temp range	100°C~500°C/212°F~932°F		80°C~480°C/176°F~896°F	
Temp stability	±5°C		±2°C	
Air flow	120L/min			
The handle type	AP-800B		SP-65A	
Soldering tip			T900-0.2SI	
Package list	Main unit: 1unit Gun Holder : 1 PCS	Hot air gun: 1 PCS AC cord: 1 PCS	Manual: 1 PCS Nozzles: 4 PCS	Iron Handle Set: 1PCS Iron Stand: 1PCS
Standard Packing	Inner box: 29.5x24.8x18.8(cm) N.W.: 2.75kg G.W.: 3kg Carton: 6PCS/Carton Size: 48x37x42(cm) N.W.: 18kg G.W.: 18.8kg			
Applicable	● Institutes ● Enterprises ● Education and practice ● Maintenance ● Hobby			

Nozzles details in page 30.

AT852D



Lead-free & ESD Safe Premium Digital Hot Air Station



AT850D



Lead-free & ESD Safe Premium Digital Hot Air Station



Features:

- Closed-loop and MCU zero crossing design for achieving fast heating-up, accurate and stable control.
- High power diaphragm pump with high pressure make it suitable for various nozzles.
- Patented heater for obtaining fast heating-up and extending lifespan.



Spiral heater HR-2550

Specification:

Item No	AT852D	AT850D
Voltage	AC(100V/110V/120V 220V/230V/240) 50/60Hz	
Power	550W	550W
Temperature range	100°C~500°C	100°C~500°C
Air flow	23L/min	23L/min
The handle type	AP-550B+	AP-550B+
Pump	Diaphragm pump	High power diaphragm pump
Timing function	No function	20~600s
Noise	<50dB(A)	<50dB(A)
Package list	Main Unit: 1PCS Gun Holder: 1PCS	Hot Air Gun: 1PCS AC Cord: 1PCS Manual: 1PCS Nozzle: 2PCS
Standard packing	Inner box: 33x27.2x19.5(cm) N.W.: 3.8kg G.W.: 4.2kg Carton: 6PCS/Carton Size: 56x35x61.5(cm) N.W.: 22.5kg G.W.: 23.8kg	Inner box: 33x27.2x19.5(cm) N.W.: 3.58kg G.W.: 3.87kg Carton: 6PCS/Carton Size: 56x35x61.5(cm) N.W.: 23.2kg G.W.: 24.3kg
Applicable	<ul style="list-style-type: none"> ● Production line ● Enterprises ● Maintenance 	<ul style="list-style-type: none"> ● Institutes ● Education and practice ● Hobby

Nozzles details in page 31.

AT8502D ESD SAFE

2-in-1 Intelligent Lead-free LCD Digital Rework Station



Features:

- MCU and PID algorithm controlled temperature be more accurate.
- Digital temperature calibration and switchable temperature units make it versatile.
- Diaphragm pump with high pressure make it suitable for various nozzles.
- Intelligence cooling system and deferred power-off function to extend handpiece lifespan.
- Patented heater for obtaining fast heating-up and extending lifespan.
- Automatic standby function to save more energy.

Specification:

Item No	AT-8502D	
Voltage	AC(100V/110V/120V 220V/230V/240) 50/60Hz	
Total Power	700W	
Name	Soldering station	Hot air station
Power	50W	550W
Temperature range	200°C~480°C	100°C~500°C
Pump		Diaphragm
Air flow		23L/min
The handle type	AP-50	AP-551B
Soldering tip	T900-B	
Noise		<50dB(A)
Package list	Main Unit: 1PCS Hot Air Gun: 1PCS Manual: 1PCS Iron Handle Set: 1PCS Gun Holder: 1PCS AC Cord: 1PCS Nozzle: 4PCS Iron Stand: 1PCS	
Standard packing	Inner box: 35.4x33x19.4(cm) N.W.: 4.85kg G.W.: 5.31kg Carton: 4PCS/Carton Size: 68x38x42(cm) N.W.: 21.2kg G.W.: 22.3kg	
Applicable	<ul style="list-style-type: none"> <li style="width: 50%;">● Thermoplastic soldering <li style="width: 50%;">● On-site soldering for PVC/PE/PP/PVDF etc. <li style="width: 50%;">● Education and practice <li style="width: 50%;">● Maintenance 	

Nozzles details in page 31.

Soldering tips (T900)

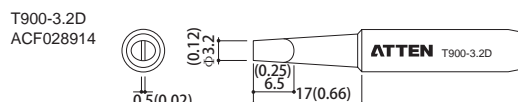
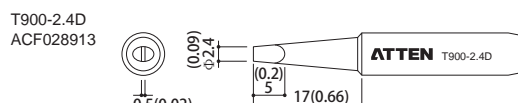
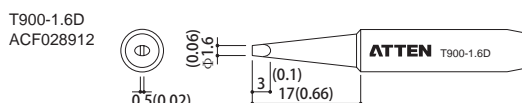
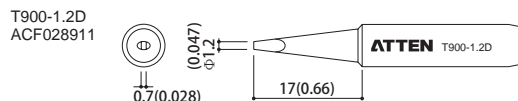
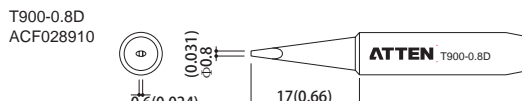
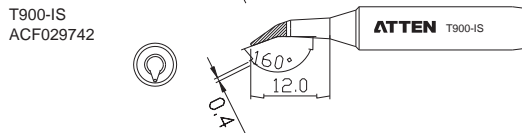
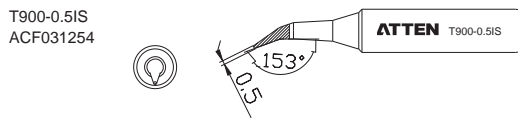
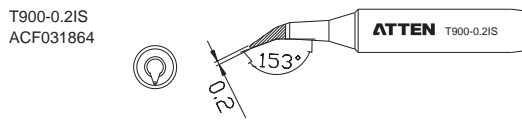
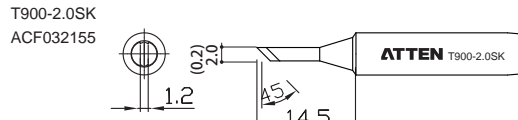
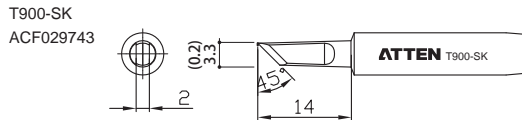
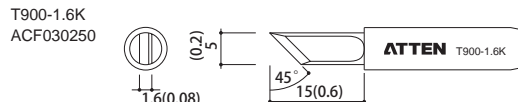
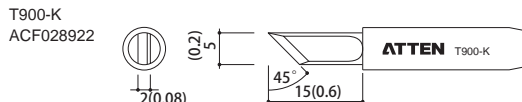
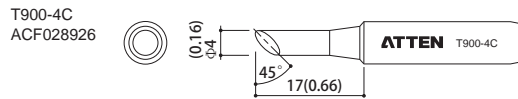
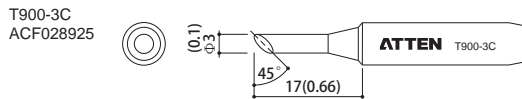
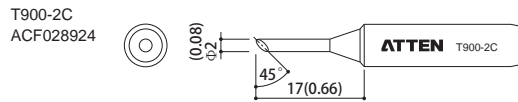
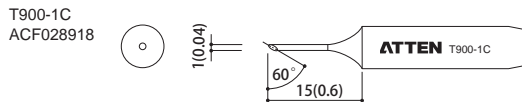
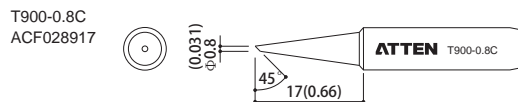
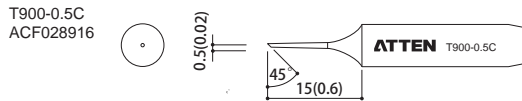
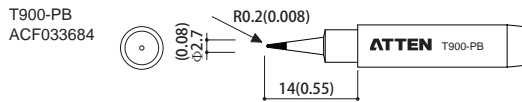
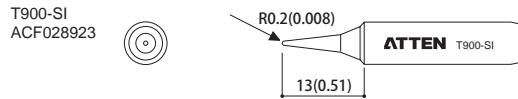
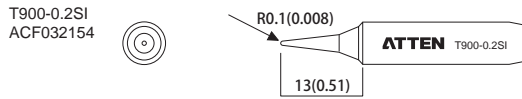
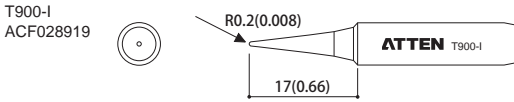
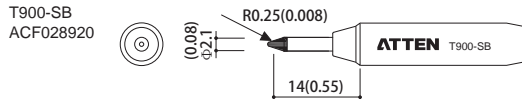
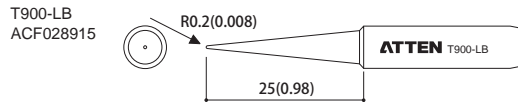
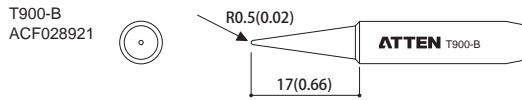

Nozzles (Applicable models: AT8586 AT858D+ ST-8800D ST-8802)

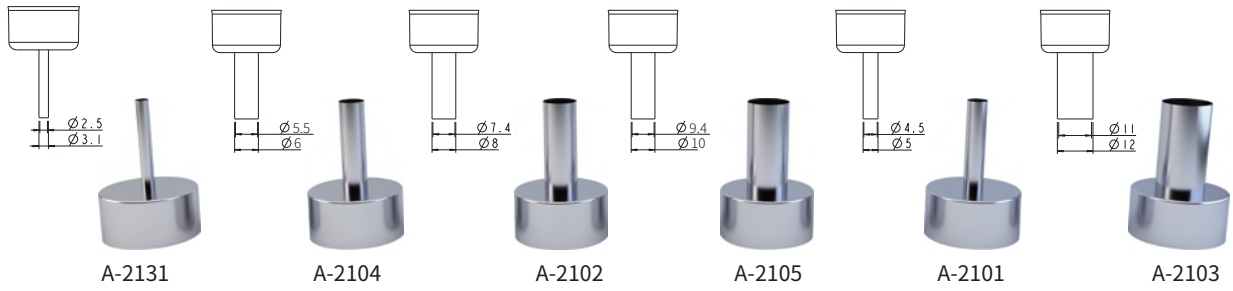



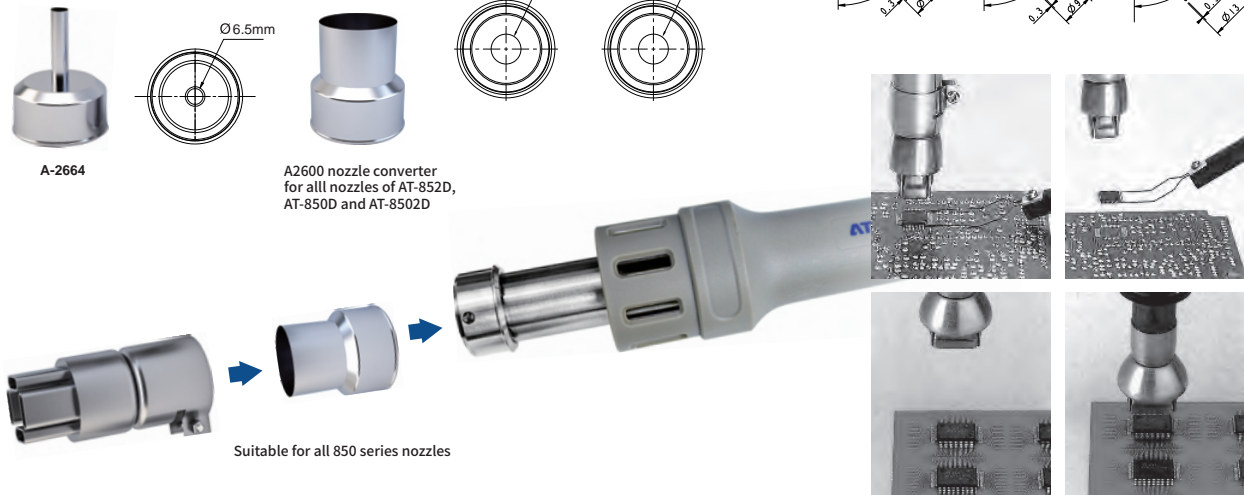
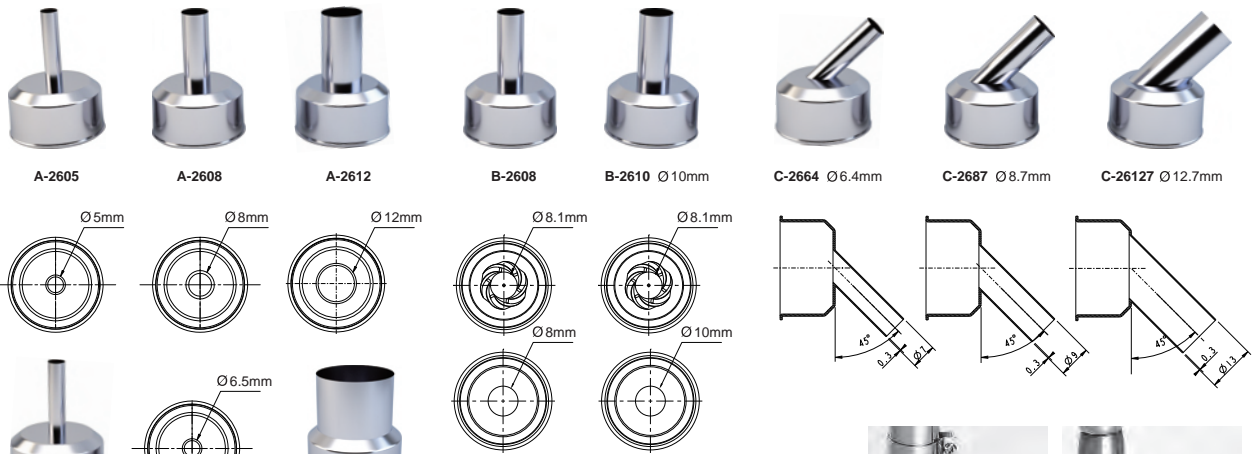



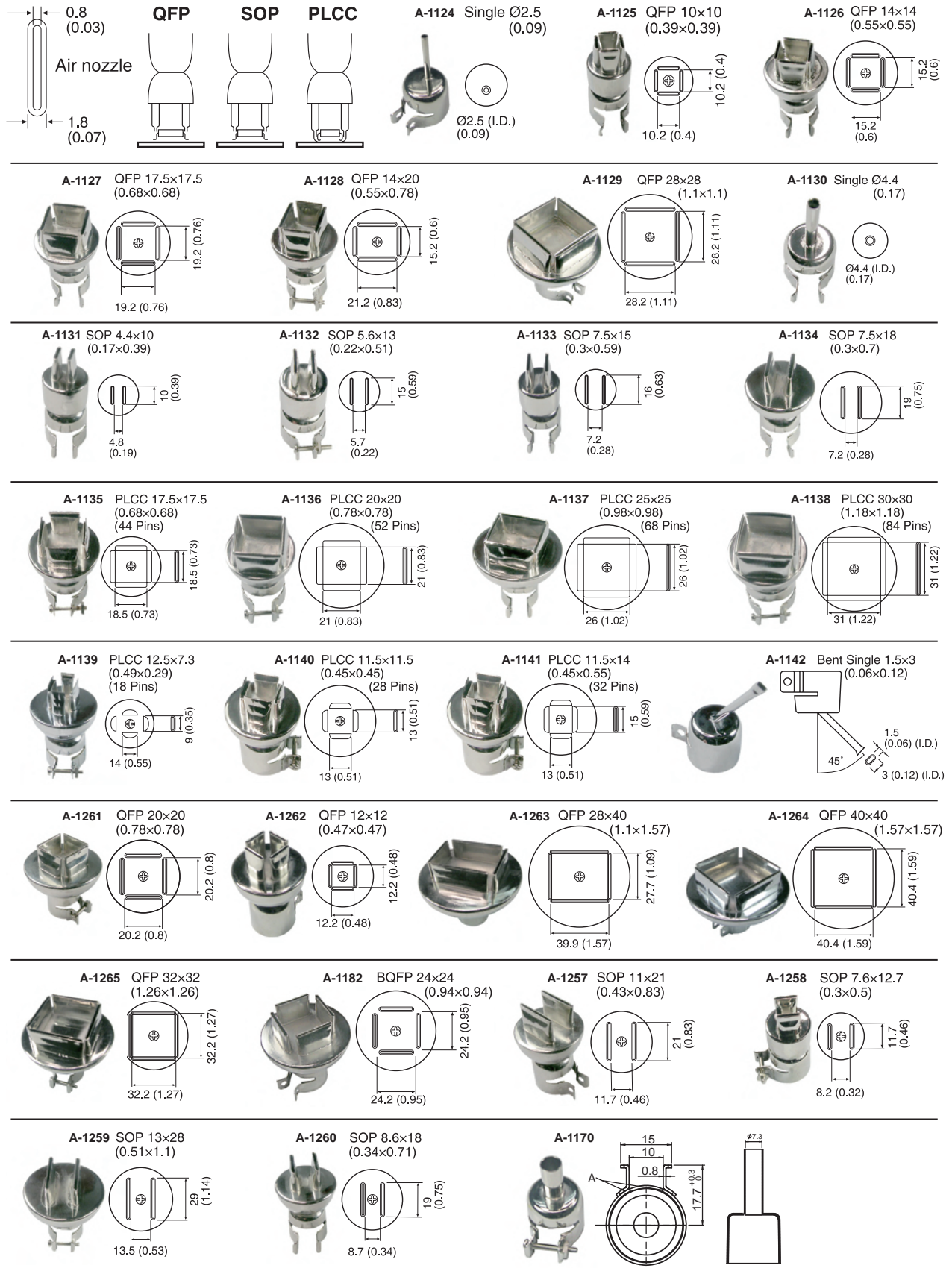















Nozzles (Applicable models: ST-862D)



Nozzles (Applicable models: AT850 AT852 AT8502)



Handle of Soldering station and Hot air station

Category	Item No	Pictures	Applicable models
The soldering station handle	AP-50		AT-937/AT-8586/AT-8502D ROHS
	AP-65		AT-937A(Pluggable heating element) ROHS
	AP-65A		AT-989/AT-989D ROHS
	SP-65A		ST-8802 ROHS
	SP-60		ST-60 ROHS
	SP-80		ST-80 ROHS
	SP-100		ST-100 ROHS
	SP-990		ST-909 ROHS
	AP-60		AT-938D ROHS
	AP-80		AT-980E ROHS
	SP-65		ST-965(Pluggable heating element) ROHS
	SP-90B		ST-2090D ROHS
	Y-950		ST-9150(Integrated) 50W ROHS
	Y-9130		ST-9150(Integrated)130W ROHS
	Y-9150		ST-9150(Integrated)150W ROHS
	N-9100		ST-9150(Integrated Tweezers)100W ROHS
	SP-H150		ST-1503(Integrated Tweezers)100W ROHS
	The hot air station handle	AP-700B	
AP-550B+			AT-850D/AT-852D ROHS
AP-551B			AT-8502D ROHS
AP-552B			MS-900 ROHS
AP-102B			ST-862D ROHS
AP-800B			ST-8800D/ST-8802 ROHS

GT-2010+

USB Soldering Iron



Features:

- Especially suitable for precision welding.
- USB standard interface of power bank or adapter supply it with electricity.
- Portable design. Can be carried after handle cap inserted if it's hot.
- Contact temperature-sensed design, make its temperature sensor more sensitive and temperature more accurate.
- Smart recognition of working or non-working status.
- Multiple soldering tips for option.

Item No	GT-2010+
Voltage	5V DC
Power	10w
Temperature range	100 C ~ 450 C
Temperature Stability	±2 C (in still air, no load)
Heater	10W integrated heater (T10-0.5I)
Temperature offset range	±50°C/±90°F
Auto-sleep mode	Support
Package list	Manual: 1PCS Certificate of quality: 1PCS USB Soldering iron : 1 Unit Soldering iron stand: 1PCS
Standard Packing	Inner box : 31x15x9(cm) N.W. : 0.56kg G.W. : 0.6kg Carton : 18pcs/carton Size : 46.5x32.5x54.5(cm) N.W. : 10kg G.W. : 10.8kg
Applicable	<ul style="list-style-type: none"> ● Production line ● Institutes ● Enterprises ● Education and practice ● Maintenance ● Hobby

Note: T10 series soldering tip details in page 35.

ST Series Soldering Iron



Features:

- Automatic sleep after 10 minutes inactivity.
- Automatic shut down after 20 minutes inactivity.
- Build in PID system.
- Shortcut temperatures adjust by button.
- LCD / LED display design.
- ESD safe
- Soldering tip designed separate from heater and using exchangeable T2080, T2150, T900 series to save use-cost.



Optional soldering iron stand S-11

Specification:

Pictures					
Item No	ST-2065D	ST-2080	ST-2080D	ST-2150	ST-2150D
Power	65W	80W	80W	150W	150W
Temperature range	80°C~480°C	5set adjustment	80°C~480°C	5set adjustment	80°C~480°C
Temperature stability	±2°C	±2°C	±2°C	±2°C	±2°C
Heater	Four-core PTC heater HS-2065D	Four-core PTC heater HS-2080	Four-core PTC heater HS-2080	Four-core PTC heater HS-2150	Four-core PTC heater HS-2150
Heating indication	Blue LED	Blue LED	Blue LED	Blue LED	Blue LED
Temperature unit	°C/°F	°C	°C/°F	°C	°C/°F
Display method	LCD	LED	LCD	LED	LCD
Soldering tip	T900-B	T2080-B	T2080-B	T2150-B	T2150-B
Package list	Soldering Iron: 1 Unit Iron holder: 1 PCS Manual: 1 PCS				
Standard Pckaging	Inner box: 5.5x4.6x29(cm) N.W.: 0.21kg G.W.: 0.25kg		Carton:50pcs/carton Size:49x30.5x33.5(cm) N.W.: 12.5kg G.W.: 13.8kg		

Note: T2080, T2150 series soldering tip details in page 35; T900 series soldering tip details in page 29.

Integrated heater (10W)

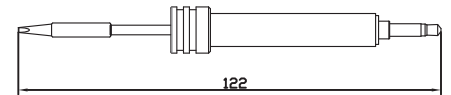

<p>T10-1.3D ACF030015</p>	<p>T10-1.2C ACF030014</p>	<p>T10-2.2D ACF030016</p>	<p>T10-3.0D ACF030017</p>	<p>T10-0.5I ACF030018</p>	<p>T10-K ACF030019</p>
-------------------------------	-------------------------------	-------------------------------	-------------------------------	-------------------------------	----------------------------

Soldering tips (T2080)

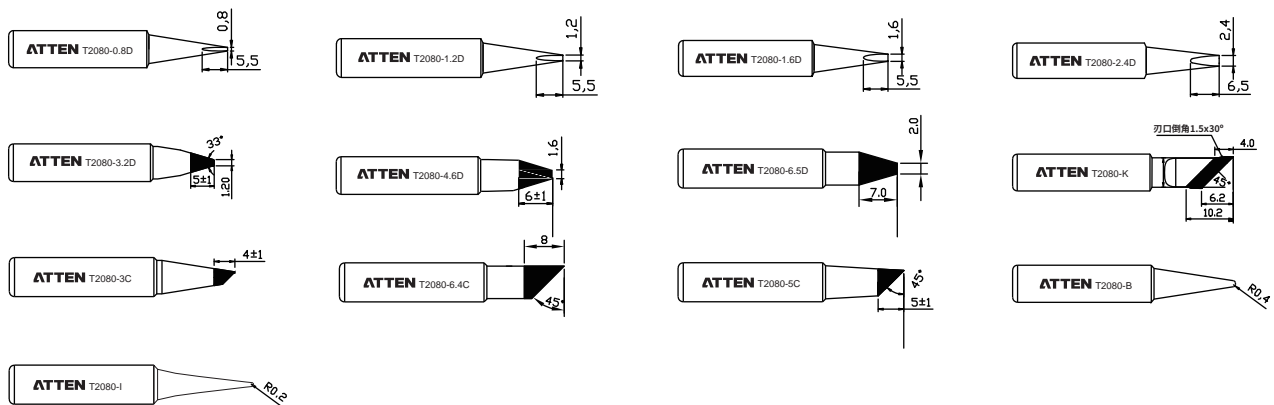

Soldering tips (T2150)

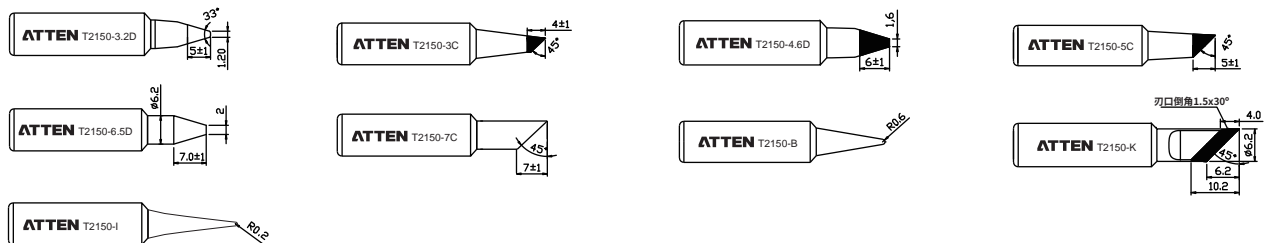

Solder Stand

S-11



S-11

- All-metal construction.
- Portable solder stand which helps.
- Work more convenience.
- The tilt angle is adjustable.

Temperature tester ST-1090

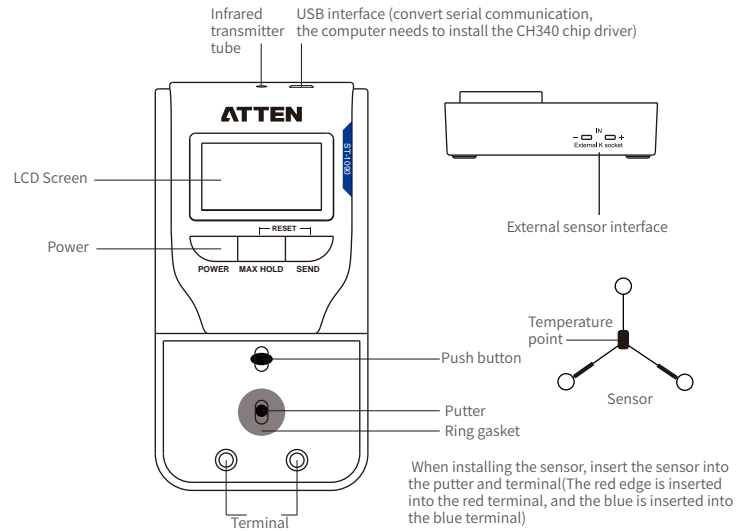

Specification:

Model	ST-1090
Resolution	1°C/1°F
Temperature range	0-800°C/32-1500°F
Accuracy Temperature	±5°C/±9°F
Sensing wire	K-type thermocouple
Display	LCD
Power	9V DC High-performance carbon battery
Operating environment	0°C~40°C/32°F~104°F
Size	75x143.5x41.5mm
Weight	185g
Package list	Host ST-1090:1 Battery: 1 K-type thermocouple test wire:1 Sensor : 10 MINI USB data line 1 Manual: 1

The IR function



A serial port function

The serial port data line is connected to the thermometer and the computer, the thermometer displays COM as shown in Figure 4-2; the thermometer sends to the computer every 100ms temperature data.



ATEN serial port assistant

Download ATEN serial port assistant from the official website (You can also use other serial port assistants)

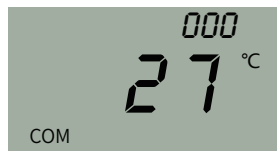
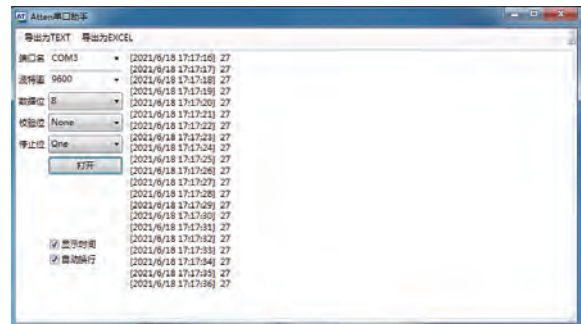

Figure 4-2 (Serial communication baud rate 9600)



ATEN serial port assistant interface

Note: convert serial communication, the computer needs to install the CH340 chip driver



FT-90A

- Made up of steel base, movable mechanical arm, fixed frame and magnifying glass, adjust proper height.
- The components can be adjusted in any direction.
- Use for observation / repair / circuit board (especially high-density, precision circuit board) welding of small objects as an extensive maintenance tool.

Magnification times: 3x
 Diameter of glass: about 9cm
 Type: Multi-direction
 Weight: 516g



Solder Smoke Absorber

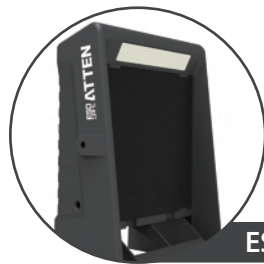

ESD safe

ST-1016/ST-1016-CP



- Desktop-type with vertical and horizontal dual-use.
- Remove soldering smoke and fumes quickly and safely.
- Highly activated carbon material with strong absorb function.
- LED lighting function.

Test Data

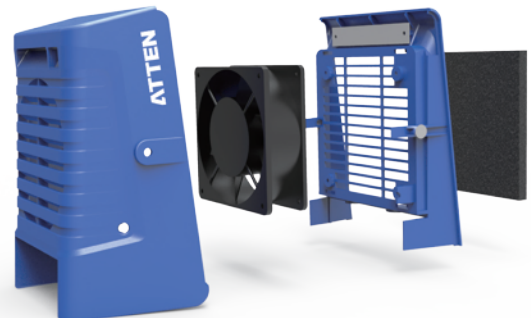
Test Item	Test Data
Air volume (vertical) m ³ /min	1.03
Air Volume (horizontal) m ³ /min	0.4
Air flow (vertical) m/s	1.0
Air flow (horizontal) m/s	2.6
Maximum suction capacity m ³ /min	1.03



Hot Melting Glue Gun

Product pictures		
Model number	JQ-050	JQ-100A
Voltage	110V~240V	
Power	50W	100W
High temperature	180°C	200°C
Glue stick	φ 7mm	φ 11mm

JQ-010



Full charge lasts 60 minutes

- Power: 8-10W
- High temperature: 180°C
- Glue stick: φ 7mm

Glue stick



φ 11mm

φ 7mm

Tweezers

AT-110

AT-111

AT-113

AT-114

AT-115



AT-110



AT-113



AT-115



AT-111



AT-114



Package



CS-05B

For cleaning soldering tips.

The soldering tip is cleaned by wiping or turning it in the metal wool. subsequently, a fine solder layer will remain which prevents fast oxidation of the soldering tip, and represents a considerable advantage compared to standard sponge cleaning.

Caution

keep the product away from children.

Only use the metal wool to clean soldering tips.

Remove the soldering tip from the metal wool directly after cleaning.



CS-08B

- Special for lean soldering tip and recycling tin residue
Anti-static / high temperature resistance.
- Pour out the tin block easily.
- Improving the problem of throwing tin while soldering, dirty and messy working environment, convenient to mass collect and take out after collecting, etc.

Soldering Wire

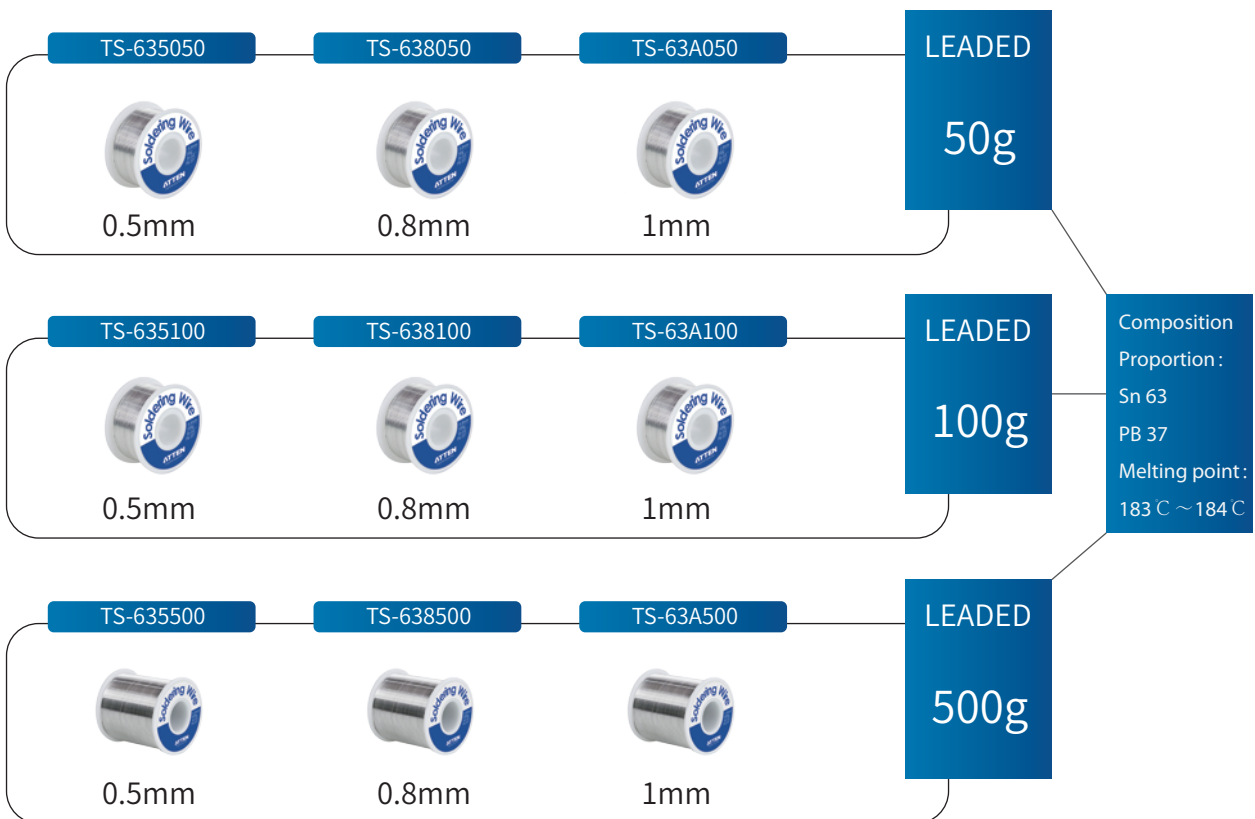
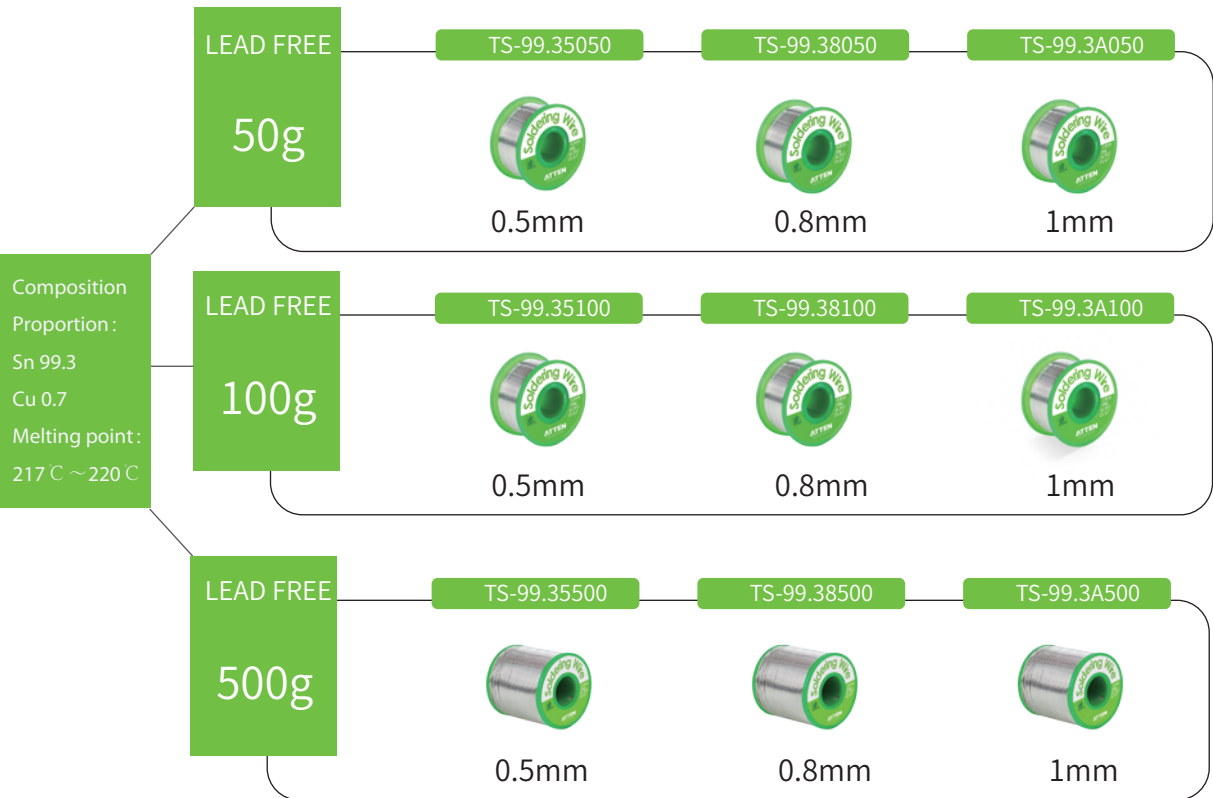

Including rosin





TJ-227

- Metal sheet base.
- The shaft can support 1kg soldering.
- The Shaft easy to take off.
- Move flexible.

TJ-228

- All-metal construction.
- Simple design.
- Soldering wire holder and sponge plate 3 in1.
- Save space, use easily.

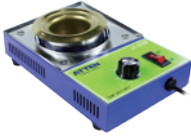
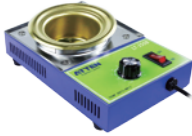

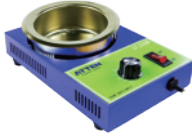
Product pictures				
Item	LT-360B	LT-350B	LT-380B	LT-310B
Power	150W	200W	250W	300W
Voltage	220V~240V	220V~240V	220V~240V	220V~240V
Temperature range	50~520°C	50~520°C	50~480°C	50~480°C
Solder capacity	0.3KG	0.5KG	1.6KG	2.2KG
Crucible Size	φ 36mm	φ 50mm	φ 80mm	φ 100mm
Melting time	10min	10min	20min	20min

Soldering Wick

AT-0815

WIDTH
0.8mm

LENGTH
1.5m



AT-1515

WIDTH
1.5mm

LENGTH
1.5m

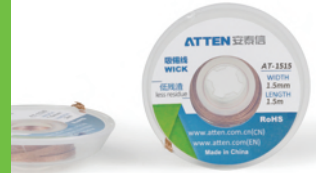

AT-2015

WIDTH
2.0mm

LENGTH
1.5m

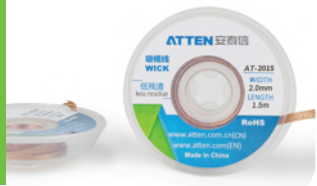

AT-2515

WIDTH
2.5mm

LENGTH
1.5m



AT-0820

WIDTH
0.8mm

LENGTH
2m



AT-3515

WIDTH
3.5mm

LENGTH
1.5m

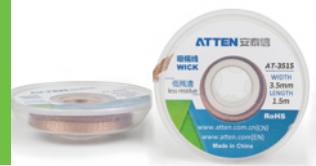

AT-1520

WIDTH
1.5mm

LENGTH
2m

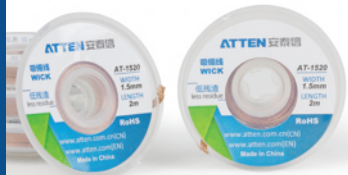

AT-2020

WIDTH
2.0mm

LENGTH
2m



AT-2520

WIDTH
2.5mm

LENGTH
2m



AT-3520

WIDTH
3.5mm

LENGTH
2m



Including soldering flux

DESOLDERING TOOL

AT-E330A AT-E330P AT-E210D

ESD safe

AT-E330A



AT-E330P

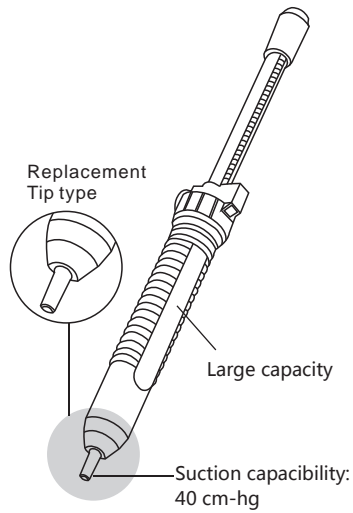
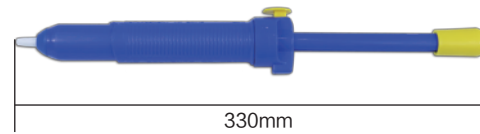

The Desoldering Pump come with high vacuum force especially made for clearing circuit boards in rework jobs and field repair.

- Piston with double oil seals: no air leakage guarantee.
- Soft handle delivers comfortable grip and non-slip function.
- Compact size.
- Anti-rust spring.
- Built-in tip for easy replacement.
- Quick and easy solder residue clearance.

AT-E210D

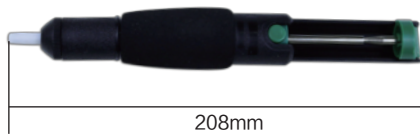

Vacuum pick-up tool

AT-B778



AT-B778

Item	Size	Pcs	Other
Suction disc S-1	φ3mm	2	
Suction disc S-2	φ7mm	2	
Suction disc S-3	φ10mm	2	
Suction nozzle Y-1	/	1	Straight
Suction nozzle Y-2	/	1	Bent

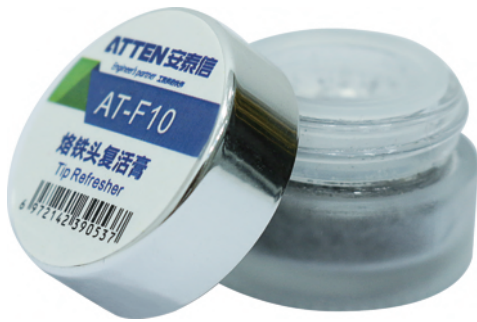

AT-F10

- Remove oxidizing material from soldering tip and tin the tip again.
- Do not contain diammonium phosphate, no damage to circuit board.
- Environmental protection, no hazardous substance.
- It's reusable.



TR-045

- Remove oxidation film.
- Prevent oxidation.
- Reduce surface tension.

Weight: 45g

AT-H20



Model	AT-H20	Dimensions	φ29x34x101mm
G.W	20g	N.W	10g
Color	Light yellow solid	Certification	ROHS

AT-H40



Model	AT-H40	Dimensions	φ59x27mm
G.W	40g	N.W	36g
Color	Light yellow solid	Certification	ROHS

AT-H60



Model	AT-H60	Dimensions	φ72x28mm
G.W	60g	N.W	56g
Color	Light yellow solid	Certification	ROHS

AT-FJ1



AT-FJ2



- Strong anti-static . The wrist strap can dissipate the static electricity of the human body
- High safety performance. The wrist strap is made of thermoplastic material with light, Thin and soft, it is safe to contact with human skin and easy to use.
- Strong resistance. the impedance of the wrist strap can reach $10^4 \Omega$

Wrist Strap On-line Monitor

AT-518-1



Output: 6V DC
 Size: 62x45x29(mm)
 Weight: 41g(excluding power adapter)

Input: AC 220V
 Material: ABS
 Consumption: 1.8W



AT-518-2

Output: 6V DC
 Size: 103x56x29(mm)
 Weight: 74g(excluding power adapter)

Input: AC 220V
 Material: ABS
 Consumption: 1.8W



- When the grounding system of the human body wrist strap is working and operating normally:there is no voice and LED green light on.
- When the grounding system of the human body wrist strap is broken down: there is alarm voice and LED red light flashing.

APS15-3A/APS22-5A

COMMUNICATION MAINTENANCE DC REGULATED VOLTAGE POWER SUPPLY



Overview

APS series communication maintenance power supply is designed for the needs of communication maintenance technicians, training schools and related engineering research and development personnel. The product adopts series type regulated voltage scheme with the current best stability and is controlled by digital MCU chip. It features very high stability and low ripple, simple operation and control, and all kinds of protection functions, especially suitable for use in the communication industry.

Application

- College training education
- Universal testing in R&D laboratory
- Maintenance of communications equipment

Technology specification and function features:

Model	APS15-3A	APS22-5A
Input Voltage	230VAC/115VAC(Optional)	
Rated output voltage	0-5V/0-15V (dual steps)	0-22V (continuously adjustable)
Rated output current	0.5A/3A (dual steps)	0-0.5A/0-5A (continuously adjustable)
Rated output power	56W (including USB interface output)	125W (including USB interface output)
Ripple and noise	$CV \leq 0.5mV_{rms}$	$CV \leq 0.5mV_{rms}(5Hz \sim 1MHz)$
Line Regulation	$CV \leq 0.01\% + 3mV$	$CV \leq 0.01\% + 3mV$ $CC \leq 0.1\% + 3mA$
Load Regulation	$CV \leq 0.01\% + 8mV$	$CV \leq 0.01\% + 4mV(I < 3A)$
set resolution	Voltage:3mV	Voltage:3mV Current:1mA
Protection Function	OCP(support automatically recovery)/OHP	OCP(support automatically recovery)/constant overcurrent/OHP
Other Functions	coarse tuning/ fine tuning switch, 5V/ 15 switch, 0.5A/ 3A switch and parameters locking	coarse tuning/ fine tuning switch, 0.5A/5A switch and parameters locking
USB interface	Fixed 5V output($\pm 5\%$), maximum 2.1A output (overcurrent protection, stop outputting)	support QC quick charge agreement maximum 3A output
Read Back Accuracy	LCD display: $\pm(0.5 \pm 2 \text{ digits})$ Current pointer display: Class-2.5	
Heat-dissipating method	Smart fan control	
Working condition	Temp:0~40°C Humidity: <80%	
Storage condition	Temp:-20~70°C Humidity: <80%	
Size(WxHxD)	88*150*215(mm)	
N.W	2.5Kg	3.6Kg

Features

- MCU-Digital control, series adjustment mode control, low ripple, low noise, and high stability.
- The double-type head design is more suitable for the use of communication equipment products.
- Fast dynamic load response speed, optimized processing for communication equipment.
- The product is designed with cut-off self-recovery protection function and over-temperature protection function.
- Independent USB interface, providing 3A current output capability, with over-current and short-circuit protection support QC quick charge agreement.
- Voltage and current are switched with two gears to adapt to different equipment.
- Built-in voltage gear automatic adjustment function, which can be more suitable for full load use.
- The digital encoder adjusts the voltage, and can switch between coarse adjustment and fine adjustment function, more precise control and longer service life.
- With output adjustment lock function, alarm prompt function, which can effectively prevent wrong operation.
- Intelligent fan control is automatically controlled according to the internal power device temperature.

TPR3003T/TPR3005T

LINEAR ADJUSTABLE DC REGULATED VOLTAGE POWER SUPPLY

Application

- Electronic products testing, verification
- Equipment maintenance, aging
- College training education
- Automotive electronic circuit power supply testing aging
- Research and development technology laboratory general test

Features

- It adopts LCD screen, high-precision double 4-bit voltage and ammeter head display, automatic calculation and display of output power.
- Rated range voltage, current continuously adjustable output.
- Constant voltage CV/ constant current CC mode automatically switch seamlessly.
- Voltage tracking output protection function, independent and perfect protection circuit.



- The product is designed with full power, super loading capacity, and can be used at full load for a long time.
- Enhanced heat dissipation system with long life double-ball fan ensure durable work, no protection.
- Panel door cover type protection to prevent wrong adjustment of parameters.

TPR series technology specification and function features:

Model	TPR3003T	TPR3005T
Rated output voltage	0-30V	
Rated output current	0-3A	0-5A
Power supply voltage	220V±10%, 50HZ/60HZ (100V/117V/200V/217V/234V optional)	
Operation condition	temperature: 0℃~40℃ relative humidity: <80%	
Storage condition	temperature-20℃~80℃ relative humidity: <80%	
Rated output power	90W	150W
Power supply effect	CV≤0.01%+3mV CC≤0.2%+1mA	
Load effect	CV≤0.01%+5mV CC≤0.2%+5mA	CV≤0.01%+7mV CC≤0.2%+7mA
Ripple and noise	(5Hz~1MHz)CV≤0.5mVr.m.s CC≤3mAr.m.s	(5Hz~1MHz)CV≤1mVr.m.s CC≤5mAr.m.s
Display	4 digits	
Voltmeter display precision	±0.5%rdg+2 bit	
Ammeter display precision	±0.5%rdg+2 bit	
High voltage test	leak current≤1mA(test condition AC-GND 1700VAC/2s)	
Insulation impedance	insulation impedance≥7MΩ((test condition AC-GND 500VDC/5s)	
Working method	constant voltage/constant current	
Protection method	current-limiting, voltage reduction, short-circuit protection, over temperature protection, over voltage protection	
Heat-dissipating method	air cooling	
Size (WxHxD)	W125xH170xD275mm	
Standard Packing		
Inner box: 37.9x23x27.4(CM)	N.W.: 5KG G.W.: 5.3KG	N.W.: 6.2KG G.W.: 6.5KG

TPR32-5A / TPR75-2A

LINEAR PROGRAM-CONTROLLED ADJUSTABLE REGULATED VOLTAGE POWER SUPPLY

Application

- Universal testing in R&D laboratory
- Pure power supply for radio frequency, microwave circuits or components
- Feature verification and fault diagnosis of devices or circuits
- Quality control and quality inspection
- Power supply for automotive electronic circuits
- Teaching experiments
- Production automation testing

Features

- It adopts double four-position high-precision voltage, ammeter head and pure MCU digital control output for better stability and higher precision.
- Product constant voltage CV / constant current CC mode, which enables continuously adjustable output within the rated range.
- It can be converted to external control mode, external input control voltage, used to control the main power supply voltage and current output.
- It has extended master-slave parallel, series operation mode, which is more convenient for user to use series-parallel expansion.
- Provide 10 convenient and fast parameter storage functions (including OVP and OCP setting values), which is convenient for users to quickly and directly call the output
- Provide external monitoring function for main output voltage and current parameters, which can be connected to a higher precision meter for display.
- It has functions of storable output parameters, status lock, and alarm.
- The intelligent cooling system adopts a double ball fan to automatically control the fan speed according to the internal temperature, making it quieter and longer-lived.
- Support computer program control, standard RS232 communication interface.



Technology specification and function features:

Model	TPR32-5A	TPR75-2A
Power supply voltage	AC 240V/230V/220V/110V/120V Optional	
Rated output voltage	0~32V	0~75V
Rated output current	0~5A	0~2A
Rated output power	160W	150W
Ripple and noise	CV \leq 0.5mVrms CC \leq 1mArms	CV \leq 1mVrms CC \leq 1mArms
Power supply effect	CV \leq 0.01%+3mV CC \leq 0.2%+3mA	CV \leq 0.01%+5mV CC \leq 0.2%+2mA
Load effect	CV \leq 0.01%+5mV CC \leq 0.2%+3mA	CV \leq 0.01%+3mV CC \leq 0.2%+5mA
Display accuracy	$\pm(0.5\%rdg+2 \text{ Digit})$	Voltage: $\pm(0.5\%rdg+3 \text{ Digit})$ Current: $\pm(0.5\%rdg+2 \text{ Digit})$
Protection functions	OVP/OCP/OHP Protection	
Heat-dissipating method	Intelligent speed regulation air cooling	
Operating temperature	Temp: 0~40 °C Humidity: <80%	
Storage temperature	Temp: -20~70 °C Humidity: <80%	
Size (WxHxD)	W125xH170xD260mm	
Standard Packing	Inner box: 34x20x25(cm)	N.W:4.3KG G.W:5KG

TPR6005T/TPR6010T

HIGH POWER CC/CV LINEAR POWER SUPPLY

Application

- Automotive electronic testing
- Photovoltaic new energy field
- Education, scientific research, laboratory
- Electromechanical field
- LED lighting field
- Other testing, product aging testing

Features

- High-resolution voltage/current display (4-digit display).
- Low ripple, low noise and pure DC output, with high reliability.
- Both voltage/current adjustments use 10-turn high-precision potentiometer knobs.
- With constant voltage CV/constant current CC mode, continuously adjustable output within the rated range.
- Provide perfect protection function, the product is suitable for various environments.
- Intelligent heat dissipation, temperature control double ball fan, low noise heat dissipation.
- With remote compensation function, it can effectively ensure product accuracy when used remotely.



TPR series technology specification and function features:

Model	TPR6010T	TPR6005T
Rated output power	600W	300W
Rated output voltage	0~60V	0~60V
Rated output current	0~10A	0~5A
Power supply voltage	230VAC/115VAC(Optional)	
Voltage		
Power supply effect	$\leq 0.005\% + 1\text{mV}$	
Voltmeter display precision	$\pm(0.1\% + 2\text{digits})$	
display resolution	10mV	
Load effect	$\leq 10\text{mV}$	
Voltage ripple	0.8mV(rms)	
Current		
Power supply effect	$\leq 1\text{mA}$	
Voltmeter display precision	$\pm(0.2\% + 2\text{digits})$	
display resolution	1mA	
Load effect	$\leq 2\text{mA}$	
Current ripple	$\leq 4\text{mA(rms)}$	
Protection functions	OVP/OCP/OHP Protection	
Heat-diss-pating method	Intelligent speed regulation air cooling	
N.W	13.5KG	11KG
Size(W*H*D)	270*178*350(mm)	

TPR3020T/TPR3010T

HIGH POWER CC/CV LINEAR POWER SUPPLY

Application

- Automotive electronic testing
- Photovoltaic new energy field
- Education, scientific research, laboratory
- Electromechanical field
- LED lighting field
- Other testing, product aging testing

Features

- High-resolution voltage/current display (4-digit display).
- Low ripple, low noise and pure DC output, with high reliability.
- Both voltage/current adjustments use 10-turn high-precision potentiometer knobs.
- With constant voltage CV/constant current CC mode, continuously adjustable output within the rated range.
- Provide perfect protection function, the product is suitable for various environments.
- Intelligent heat dissipation, temperature control double ball fan, low noise heat dissipation.
- With remote compensation function, it can effectively ensure product accuracy when used remotely.



TPR series technology specification and function features:

Model	TPR3020T	TPR3010T
Rated output power	640W	320W
Rated output voltage	0~32V	0~32V
Rated output current	0~20A	0~10A
Power supply voltage	230VAC/115VAC(Optional)	
Voltage		
Power supply effect	≤0.005%+1mV	
Voltmeter display precision	±(0.1%+2digits)	
display resolution	10mV	
Load effect	≤15mV	≤10mV
Voltage ripple	0.8mV(rms)	
Current		
Power supply effect	≤2mA	≤1mA
Voltmeter display precision	±(0.2%+2digits)	
display resolution	10mA	1mA
Load effect	≤3mA	≤2mA
Current ripple	≤6mA(rms)	≤4mA(rms)
Protection functions	OVP/OCP/OHP Protection	
Heat-diss-pating method	Intelligent speed regulation air cooling	
N.W	13.5KG	11KG
Size(W*H*D)	270*178*350(mm)	

KPS3030DA/KPS3050DA

HIGH POWER ADJUSTABLE DC REGULATED VOLTAGE POWER SUPPLY

Application

- Automotive electronic testing
- Photovoltaic new energy field
- Education, scientific research, laboratory
- Electromechanical field
- LED lighting field
- Other testing, product aging use

Features

- The product has functions of adjustable constant voltage and constant current, and automatically switches state according to load.
- Switching power supply structure, with features of high power, high efficiency, light weight and strong load capacity.
- Perfect protection function, short-circuit protection, over-temperature protection, over-voltage protection.
- The voltage adjustment is made by multi-turn potentiometer, with higher adjustment accuracy.
- automatically High-power temperature-controlled fan dissipates heat according to the internal temperature of the machine.
- Full power design with high reliability.



KPS series technology specification and function features:

Model	KPS3030DA	KPS3050DA
Rated output voltage	0-30V	
Rated output current	0-30A	0-50A
Power supply voltage	220V±10%, 50Hz/60Hz	
Operation condition	temperature: 0°C~40°C relative humidity: <80%	
Storage condition	temperature-10°C~70°C relative humidity: <80%	
Rated output power	900W	1500W
Power supply effect	CV≤0.01%+3mV CC≤0.1%+6mA	
Load effect	CV≤0.01%+10mV(1≤10A) CC≤0.1%+6mA(1≤10A)	
Ripple and noise	CV≤50mVr.m.s	
Voltmeter display precision	±(0.5% of rdng+2 digits)	
Ammeter display precision	±(0.5% of rdng+2 digits)	
High voltage test	leak current≤1mA(test condition AC-GND 1700VAC/2s)	
Insulation impedance	insulation impedance≥7MΩ (test condition AC-GND 500VDC/5s)	
Working method	constant voltage/constant current	
Protection method	current-limiting, voltage reduction, short-circuit protection, over temperature protection, over voltage protection	
Heat-dissipating method	air cooling	
Size (WxHxD)	W260xH170xD380mm	
Standard Packing		
Inner box: 41x32x23 (CM)	N.W.: 6KG G.W.: 6.3KG	N.W.: 7KG G.W.: 7.3KG

TPS300P

DC SWITCHING POWER SUPPLY



Overview

TPS series power supply is a high-precision, high-reliability, constant-voltage, constant-current, constant-power switching linear regulated power supply. The product adopts innovative double voltage-regulated structure of switch regulated voltage + linear regulated voltage, and also features high efficiency and high power of switching power supply, and the low ripple and high reliability of the linear power supply.

Application

- Automated testing
- LED lighting field
- Photovoltaic new energy field
- Education, scientific research, laboratory
- Electromechanical field
- Automotive electronic testing
- Other tests, product aging use

Features

- High precision voltage, ammeter head and pure MCU digital control output for better stability and higher precision.
- Dual voltage stabilizing structure, high efficiency, low ripple, low noise output.
- Product constant voltage CV / constant current CC mode, which enables continuously adjustable output within the rated range.
- It can be converted to external control mode, external input control voltage, used to control the main power supply voltage and current output.
- It has extended master-slave parallel, series operation mode, which is more convenient for user to use series-parallel expansion.
- Provide 10 convenient and fast parameter storage functions (including OVP and OCP setting values), which is convenient for users to quickly and directly call the output
- Provide OVP, OCP, OHP protection and alarm functions.
- Provide external monitoring function for main output voltage and current parameter.
- It has functions of storable output parameters, status lock, and alarm.
- The intelligent cooling system adopts a double ball fan to automatically control the fan speed according to the internal temperature, making it quieter and longer-lived.
- Support computer program control, standard RS232 communication interface.

Technology specification and function features:

Model	TPS300P	
Rated output voltage	0~75V	
Rated output current	0~10A(Limited by output power)	
Power supply voltage	AC 115V / 230V 50~60HZ(Optional)	
Rated output power	300W	
Setting accuracy	CV: $\pm(0.1\%\text{set}+0.05\%\text{rating})$	CC: $\pm(0.3\%\text{set}+0.1\%\text{rating})$
display accuracy	CV: $\pm(0.1\%\text{rdng}+2\text{digits})$	CC: $\pm(0.2\%\text{rdng}+2\text{digits})$
Power adjustment rate	CV: $\leq 0.01\%+3\text{mV}$	CC: $\leq 0.1\%+5\text{mA}$
Load regulation	CV: $\leq 0.01\%+5\text{mV}(<5\text{A})$	CC: $\leq 0.01\%+5\text{mA}$
Ripple	CV: $\leq 5\text{mVrms}$	CC: $\leq 3\text{mArms}$
Dynamic response	$\leq 100\mu\text{s}$	
Quick access	10 group (Contain OVP OCP)	
Protection functions	OVP/OCP/OHP	
Heat-dissipating method	Smart fan control	
Weight	G.W.: 3KG	
Size(WxHxD)	125x170x260(mm)	

CP600-30V/30A/CP900-30V/30A

HIGH POWER PROGRAM-CONTROLLED DC REGULATED VOLTAGE POWER SUPPLY

Overview

CP series power supply is a high-precision, high-reliability, constant-voltage, constant-current, constant-power switching linear regulated power supply. The product adopts innovative double voltage-regulated structure of switch regulated voltage + linear regulated voltage, and also features high efficiency and high power of switching power supply, and the low ripple and high reliability of the linear power supply.

Application

- Automated testing
- Automotive electronic testing
- Photovoltaic new energy field
- Education, scientific research, laboratory
- Electromechanical field
- LED lighting field
- Other tests, product aging use



Features

- The product is suitable for 100-240V AC universal AC input, universal use for the global power grid.
- Pure digital MCU control, long-term use to ensure product accuracy, long service life, and low temperature drift.
- High-precision setting and read-back display, built-in 16-bit D/A 20-bit A/D converter
- The product has high efficiency and built-in power factor correction circuit.
- Pure hardware OVP, OCP, OHP, OPP protection, OVP/OCP protection values can be set separately.
- Front switch regulated voltage + post linear regulated voltage, double regulated voltage structure, high efficiency, and low ripple.
- With local or remote voltage acquisition, and automatic compensation function. Long-distance measurement can also ensure accuracy.
- Provide 3 groups of quick parameter storage function to quickly call the settings.
- Provide coarse adjustment and fine adjustment functions. Voltage setting accuracy is up to 1mV, current 1mA.
- Intelligent temperature-controlled fan, automatically controlling the speed of heat dissipation.
- Standard USB, RS232 communication interface, which can be connected and controlled with the PC.

CP series technical specification:

Model		CP600-30V/30A	CP900-30V/30A
AC input	Input voltage	220-240V AC	
	Frequency	47-63Hz	
	(PFC)	>0.98	
Output	Output power	0-600W (CP)	0-900W
	Output voltage	0-31V	0-31V
	Output current	0-31A	0-31A
Working method		CV/CC/CP	CV/CC
Voltage	Setting resolution	1mV	1mV
	Maximum preset voltage(105% of rating)	31V	31V
	Setting accuracy	0.05%set + 20mV	
	Line regulation	0.01% +5mV	
	Load regulation	0.1% + 5mV	
	Voltage display resolution	10mV	
	Voltage display accuracy	±(0.05% of reading + 2digits) at 23±5°C	
	Ripple noise	100mVp-p/10mVrms	
	Rise time (Rated Load)	150mS	
	Fall time (No Load)	150mS	
	Temperature coefficient	100ppm/°C(TYP Value)	
Current	Setting resolution	1mA	
	Maximum preset current (105% of rating)	31A	31A
	Setting accuracy	0.1% set +0.1% rating	
	Line regulation	0.1%+10mA	
	Load regulation	0.2%+10mA	
	Ripple noise	50mA	
	Temperature coefficient	200ppm/°C	
	Current display resolution	1mA(≤ 10A) / 10mA(≥ 10A)	
Current display accuracy	±(0.2% of reading + 30 digits) at 23±5°C		
Protection functions OVP range:0.3V-Rated Voltage+1.5V OCP range:0.3V-Rated Voltage+1.5A		OVP、OCP、OHP、OPP、SCP(short circuit protection)	
Efficiency(full load)		≥85%	
Communication method		USB、RS232	
Product size		W190xH125xD330mm	
Standard packing			
Inner box: 42.8x29.5x22.2 (cm)		N.W: 4.1KG	G.W: 5.1KG

PR35-3A-3C / PR35-5A-3C

THREE-WAY LINEAR DC REGULATED VOLTAGE POWER SUPPLY

Overview

This product has high precision, high reliability, adjustable constant voltage, constant current DC regulated voltage. The product has the advantages of simple operation, durability and complete functions.

Application

- Universal testing in R&D laboratory
- Pure power supply for radio frequency, microwave circuits or components
- Feature verification and fault diagnosis of devices or circuits
- Quality control and quality inspection
- Power supply for automotive electronic circuits
- Teaching experiments
- Production automation testing



Features

- The product adopts double four-position voltage, current display with high precision, high reliability, low ripple, low noise, low temperature drift characteristics.
- Independent hardware OVP, OCP protection, OHP protection, fast response, one step faster.
- OVP, OCP protection value can be set separately, and the application range is wider.
- Quick series and parallel operation, no need for external adapter cable, more convenient to use.
- In the series and parallel state, pure hardware shares the same current, fast dynamic response speed, which is more conducive to accurate test.
- Fully digital MCU control, button, encoder operation, longer service life, long-term guarantee of product accuracy.
- The three-way power supply is completely isolated from output, operated independently, and does not interfere with each other.
- Panel door cover protection to prevent wrong operation.
- Intelligent fan cooling system with built-in linear temperature sensor to control fan speed, with low noise and more silence.

PR series technology specification and functions:

Model	PR35-3A-3C			PR35-5A-3C		
Output Specification	Channel 1	Channel 2	Channel 3	Channel 1	Channel 2	Channel 3
Rated output power	105W	105W	5W	175W	175W	5W
	215W			355W		
Voltage						
Rated output voltage	35V		5V(Fixed)	35V		5(Fixed)
Maximum preset voltage	105% of rating (V)		–	105% of rating(V)		–
Setting resolution	1mV		–	1mV		–
Setting accuracy	0.2% set + 0.1% rating		–	0.2% set + 0.1% rating		–
Display accuracy	±(0.5% of rdng+2 digits)		–	±(0.5% of rdng+2 digits)		–
Line regulation	3mV		–	4mV		–
Load regulation	10mV		–	10mV		–
Transient response	50us		–	50us		–
Ripple noise	0.5mV(rms)		–	0.5mV(rms)		–
Current						
Current	3A		1A	5A		1A
Maximum preset current	105% of rating(A)		–	105% of rating(A)		–
Setting resolution	0.1mA		–	0.1mA		–
Setting accuracy	0.3% set +0.1% rating		–	0.3% set +0.1% rating		–
Display accuracy	±(1% of rdng+5 digits)		–	±(1% of rdng+5 digits)		–
Line regulation	5mA		–	5mA		–
Load regulation	5mA		–	5mA		–
Ripple noise	1mA(rms)		–	2mA(rms)		–
Temperature coefficient	200ppm/°C(ty p)					
Protection functions	OVP/OCP/OHP					
Series/Parallel Specification						
Voltage Tracking Characteristic	Series	≤300mV		–	≤300mV	
	Parallel	≤200mV		–	≤200mV	
Input Specification						
Nominal input rating	100V、117V、200V、217V (220V) 、234V (Factory Preset Parameter) ±10%					
Frequency	50/60Hz					
Dimension(WxHxD)	W250xH186xD385mm					
Environmental conditions						
Operating temperature	0°C to +40°C					
Operating humidity	< 85%RH					
Standard Packing						
Inner box: 47.6x35.6x27.5(CM)	N.W.: 12.4KG		G.W.: 12.8KG		N.W.: 14.2KG G.W.: 14.6KG	

PR35-3A-3CP / PR35-5A-3CP

THREE-WAY PROGRAMMABLE LINEAR DC REGULATED VOLTAGE POWER SUPPLY

Overview

This product has high precision, high reliability, adjustable constant voltage, constant current DC regulated voltage. The product has the advantages of simple operation, durability and complete functions.

Application

- Universal testing in R&D laboratory
- Pure power supply for radio frequency, microwave circuits or components
- Feature verification and fault diagnosis of devices or circuits
- Quality control and quality inspection
- Power supply for automotive electronic circuits
- Teaching experiments
- Production automation testing



Panel turnover effect

Features

- The product adopts double four-position voltage, current display with high precision, high reliability, low ripple, low noise, low temperature drift characteristics.
- Independent hardware OVP, OCP protection, OHP protection, fast response, one step faster.
- OVP, OCP protection value can be set separately, and the application range is wider.
- Quick series and parallel operation, no need for external adapter cable, more convenient to use.
- In the series and parallel state, pure hardware shares the same current, fast dynamic response speed, which is more conducive to accurate test.
- Fully digital MCU control, button, encoder operation, longer service life, long-term guarantee of product accuracy.
- The three-way power supply is completely isolated from output, operated independently, and does not interfere with each other.
- Panel door cover protection to prevent wrong operation.
- Intelligent fan cooling system with built-in linear temperature sensor to control fan speed, with low noise and more silence.
- The remote control interface supports IEEE std 482.2-1999 and SCPI Specification 1999.0.

PR series technology specification and functions:

Model	PR35-3A-3CP			PR35-5A-3CP		
Output Specification	Channel 1	Channel 2	Channel 3	Channel 1	Channel 2	Channel 3
Rated output power	105W	105W	5W	175W	175W	5W
	215W			355W		
Voltage						
Rated output voltage	35V		5V(Fixed)	35V		5(Fixed)
Maximum preset voltage	105% of rating (V)		–	105% of rating(V)		–
Setting resolution	1mV		–	1mV		–
Setting accuracy	0.2% set + 0.1% rating		–	0.2% set + 0.1% rating		–
Display accuracy	±(0.5% of rdng+2digits)		–	±(0.5% of rdng+2digits)		–
Line regulation	3mV		–	4mV		–
Load regulation	10mV		–	10mV		–
Transient response	50us		–	50us		–
Ripple noise	0.5mV(rms)		–	0.5mV(rms)		–
Current						
Current	3A		1A	5A		1A
Maximum preset current	105% of rating(A)		–	105% of rating(A)		–
Setting resolution	0.1mA		–	0.1mA		–
Setting accuracy	0.3% set +0.1% rating		–	0.3% set +0.1% rating		–
Display accuracy	±(1% of rdng+5 digits)		–	±(1% of rdng+5 digits)		–
Line regulation	5mA		–	5mA		–
Load regulation	5mA		–	5mA		–
Ripple noise	1mA(rms)		–	2mA(rms)		–
Temperature coefficient	200ppm/°C(typ)					
Protection functions	OVP/OCP/OHP					
Series/Parallel Specification						
Voltage Tracking Characteristic	Series	≤300mV		–	≤300mV	
	Parallel	≤200mV		–	≤200mV	
Input Specification						
Nominal input rating	100V、117V、200V、217V (220V) 、234V (Factory Preset Parameter) ±10%					
Frequency	50/60Hz					
Dimension(WxHxD)	W250xH186xD385mm					
Environmental conditions						
Operating temperature	0°C to +40°C					
Operating humidity	< 85%RH					
Communication interface	RS232/USB					
Standard Packing						
Inner box: 47.6x35.6x27.5(CM)	N.W.: 12.6KG		G.W.: 13KG		N.W.: 14.4KG G.W.: 14.8KG	



ISO9001:2015



Engineer's partner

SHENZHEN ATTEN TECHNOLOGY CO., LTD.

Add: Floor 8, Building 2, Senyang High-tech Park, 7 West Road
High-tech Park, Guangming New district, Shenzhen 518132, China

Tel: +86-755-8602-1373

Fax: +86-755-8602-1365

Web: www.atten.com

Email: sales@atten.com.cn

Facebook <https://www.facebook.com/attencn/>

